

Premaster Course Algorithms 1

Chapter 3: Elementary Data Structures

Christian Scheideler
SS 2018

Overview

- Basic data structures
- Search structures (successor searching)
- Dictionaries (exact searching)

Stacks and Queues

Stack: implements the LIFO (last-in-first-out) rule, i.e., the youngest element will be removed first

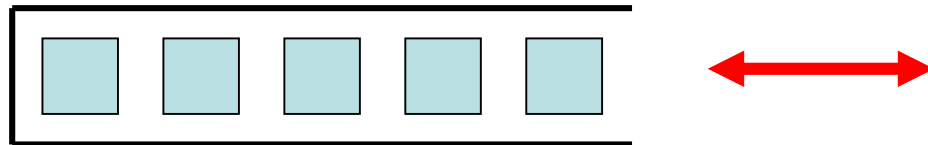

Queue: implements the FIFO (first-in-first-out) rule, i.e., the oldest element will be removed first

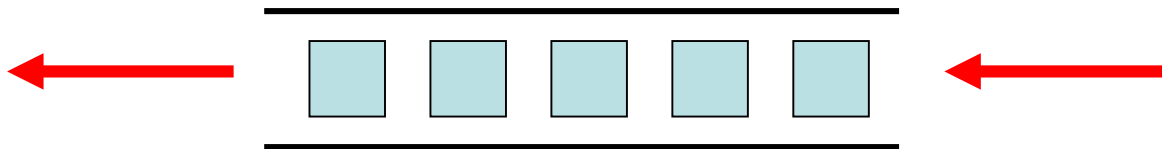

Stack

Stack operations:

- $\text{Push}(S,x)$: insert element x into stack S
- $\text{Pop}(S)$: remove youngest element from stack
- $\text{Empty}(S)$: checks if stack is empty

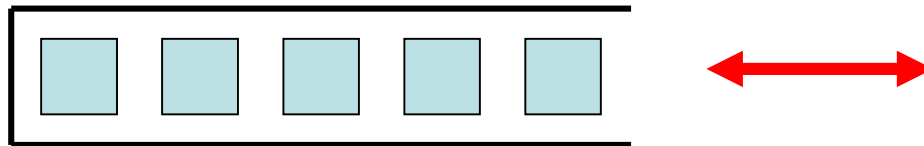

Simplest implementation:

- Array $S[1..N]$ (#elements in S never more than N)
- $S.\text{top}$: number of elements currently in $S[1..N]$

Stack

Example:



Implementation:

Push(S,x):

1. $S.top := S.top + 1$
2. $S[S.top] := x$

Pop(S):

1. if Empty(S) then error „underflow“
2. else
3. $S.top := S.top - 1$
4. return $S[S.top + 1]$

Empty(S):

1. if $S.top = 0$ then
2. return true
3. else
4. return false

Stack

Starting point:

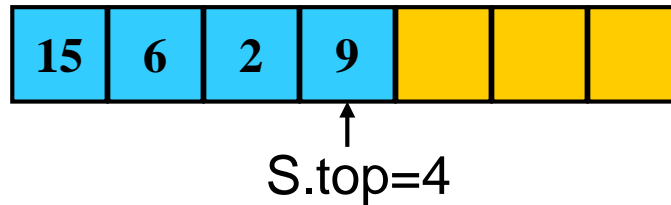

After Push(S,17), Push(S,3):

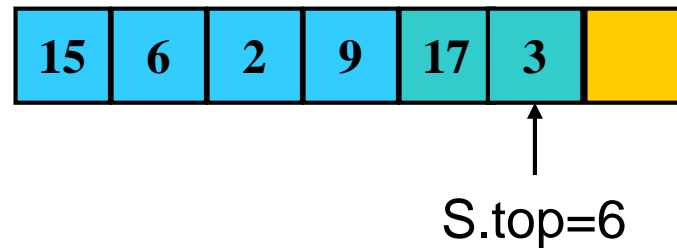

After Pop(S):

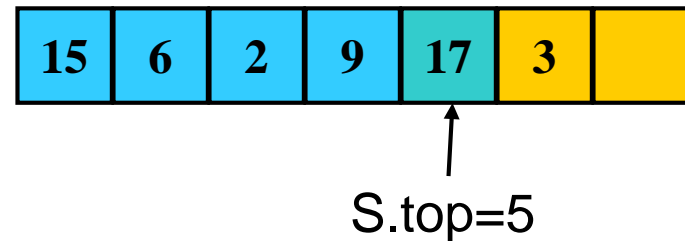

Queue

Queue operations:

- Enqueue(Q,x): insert element x into queue Q
- Dequeue(Q): remove oldest element from queue
- Empty(Q): checks if queue is empty

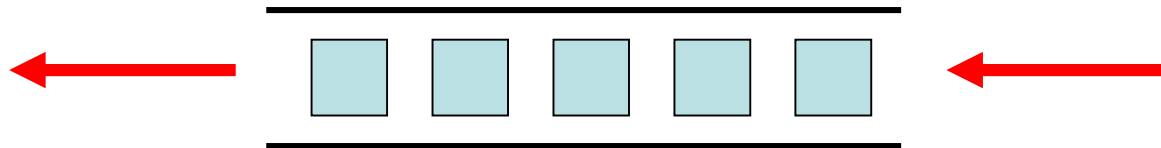

Simplest implementation:

- Array $Q[1..N]$ (#elements in Q at most N)
- $Q.head$: starting point in $Q[1..N]$
- $Q.tail$: end point (next free position) in $Q[1..N]$
- Initially, $Q.head=Q.tail=1$

Queue

Example:



Implementation:

Empty(Q):

1. if $Q.head = Q.tail$ then
2. return true
3. else
4. return false

Enqueue(Q,x):

1. $Q[Q.tail] := x$
2. if $Q.tail = Q.length$ then
3. $Q.tail := 1$
4. else $Q.tail := Q.tail + 1$

Q.head=7

Q.tail=12

Dequeue(Q):

1. if Empty(Q) then error „underflow“
2. $x := Q[Q.head]$
3. if $Q.head = Q.length$ then
4. $Q.head := 1$
5. else $Q.head := Q.head + 1$
6. return x

Queue

Example:

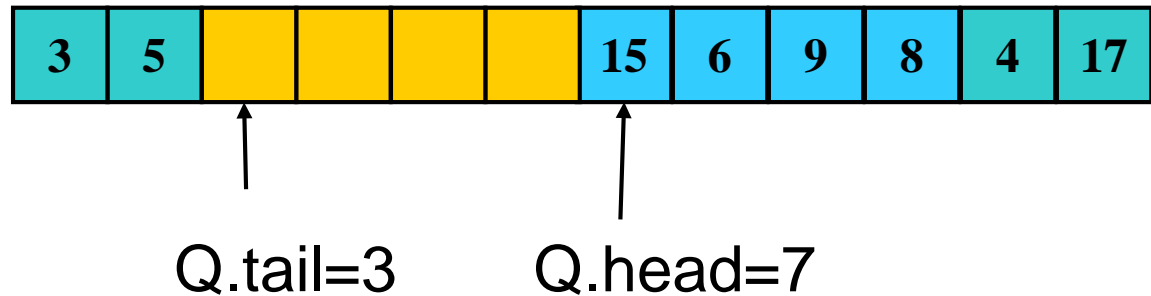

After Dequeue:

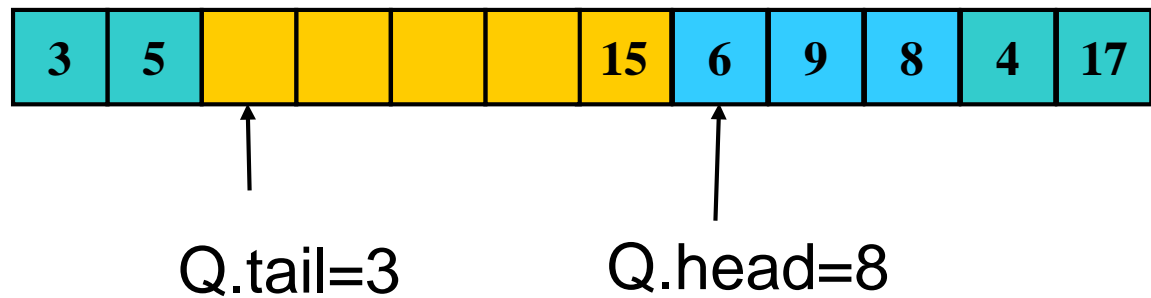

Linked Lists

List operations:

- List-Insert(L,x): insert element x into list
- List-Delete(L,x): remove element x from list
- List-Search(L,k): search for key k in list

Implementation as doubly linked list:

- L.head: refers to first element of list L
- x: element of list, which contains x.prev, X.key, and x.next
- x.prev: refers to predecessor of x (NIL: no predecessor)
- x.next: refers to successor of x (NIL: no successor)
- x.key: stores key of x

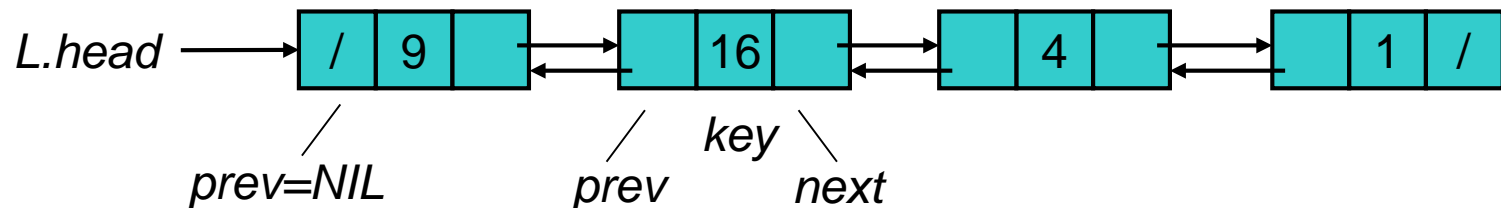

Linked Lists

Abstract view: linked list



Internal representation: linear addressable memory

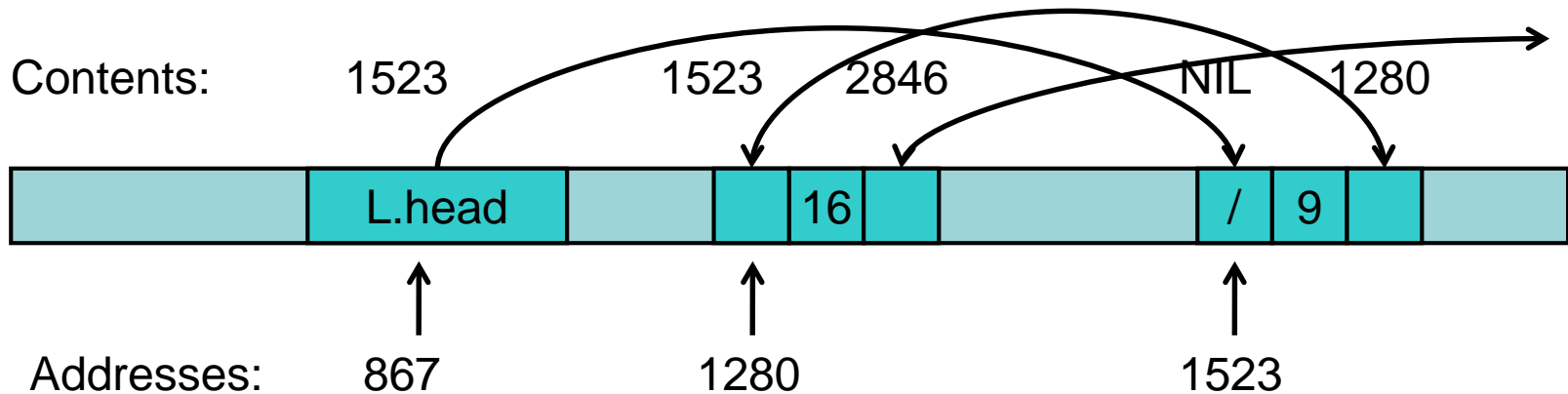

Linked Lists

List-Search(L,k):

1. $x := L.head$
2. while $x \neq NIL$ and $x.key \neq k$ do
3. $x := x.next$
4. return x

Example: List-Search(L,1)

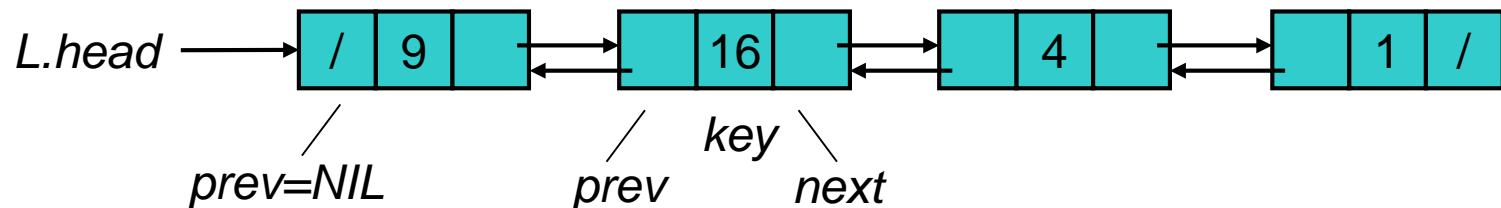

Linked Lists

List-Insert(L,x):

1. $x.next := L.head$
2. if $L.head \neq NIL$ then
3. $L.head.prev := x$
4. $L.head := x$
5. $x.prev := NIL$

x: pointer that points to address of element that needs to be inserted

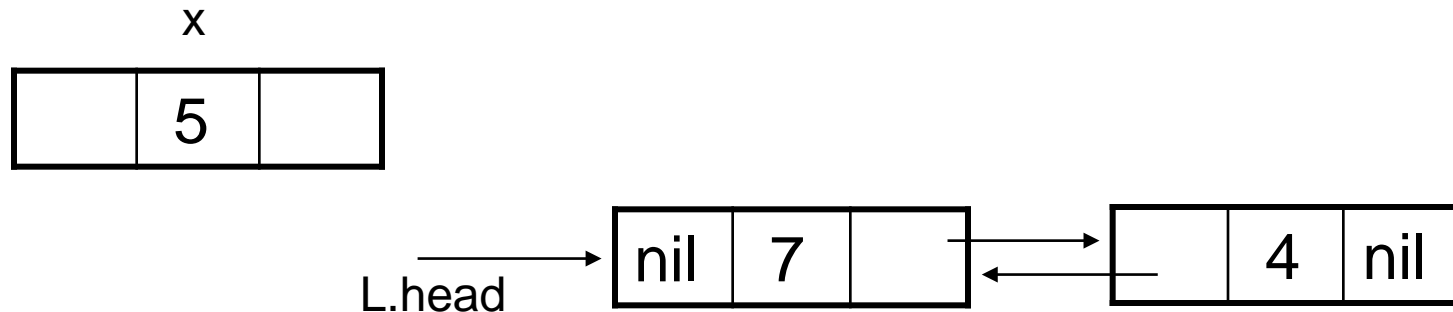

Linked Lists

List-Insert(L,x):

1. $x.next := L.head$
2. if $L.head \neq NIL$ then
3. $L.head.prev := x$
4. $L.head := x$
5. $x.prev := NIL$

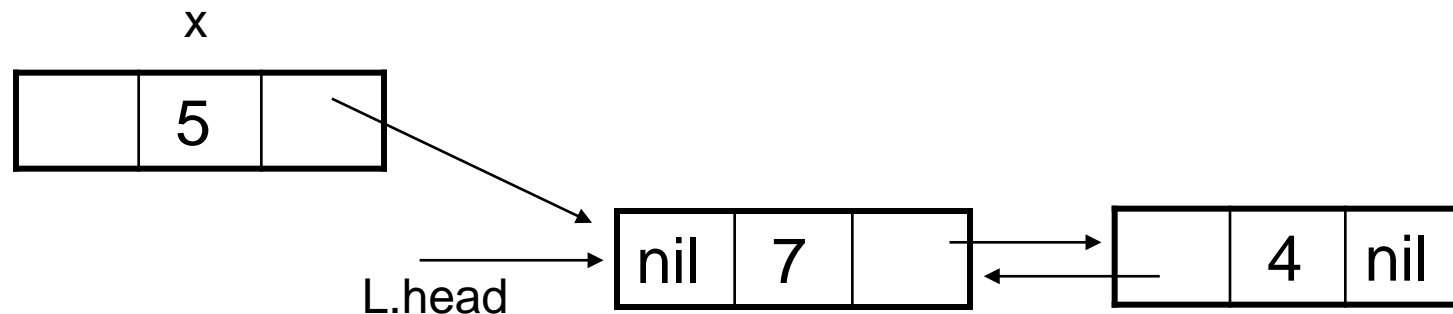

Linked Lists

List-Insert(L,x):

1. $x.next := L.head$
2. if $L.head \neq NIL$ then
3. $L.head.prev := x$
4. $L.head := x$
5. $x.prev := NIL$

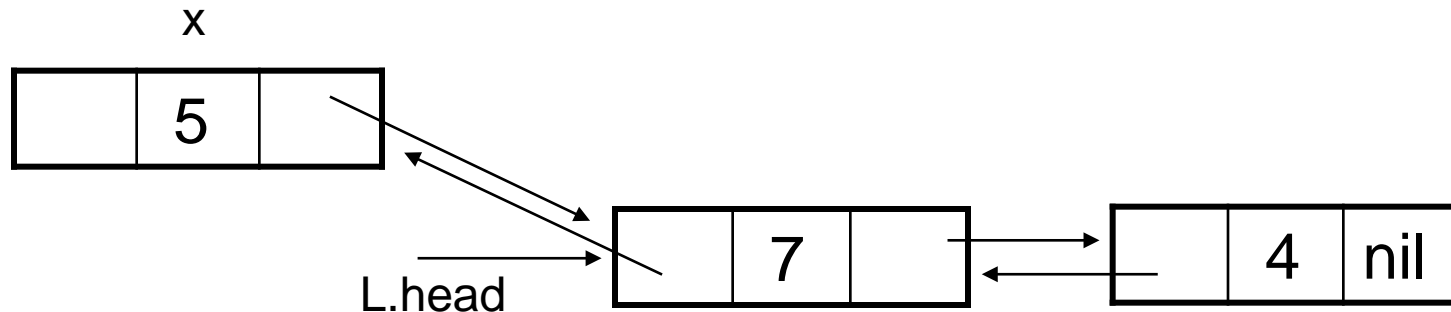

Linked Lists

List-Insert(L,x):

1. $x.next := L.head$
2. if $L.head \neq NIL$ then
3. $L.head.prev := x$
4. $L.head := x$
5. $x.prev := NIL$

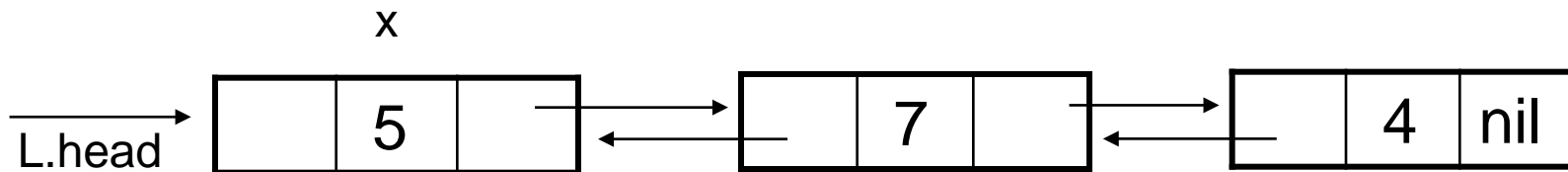

Linked Lists

List-Insert(L,x):

1. $x.next := L.head$
2. if $L.head \neq NIL$ then
3. $L.head.prev := x$
4. $L.head := x$
5. $x.prev := NIL$

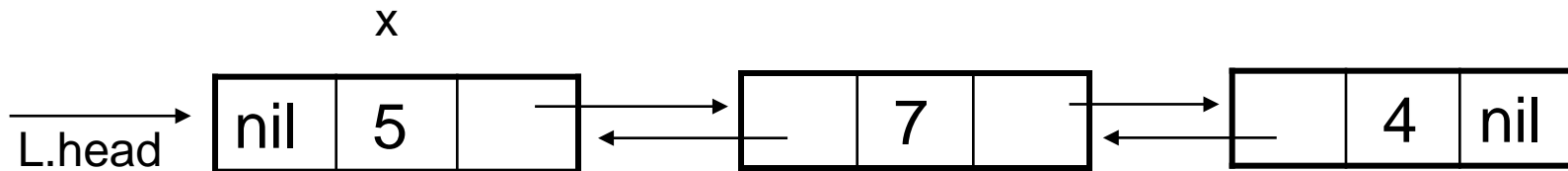

Linked Lists

List-Delete(L,x):

1. if $x.\text{prev} \neq \text{NIL}$ then
2. $x.\text{prev}.\text{next} := x.\text{next}$
3. else $L.\text{head} := x.\text{next}$
4. if $x.\text{next} \neq \text{NIL}$ then
5. $x.\text{next}.\text{prev} := x.\text{prev}$

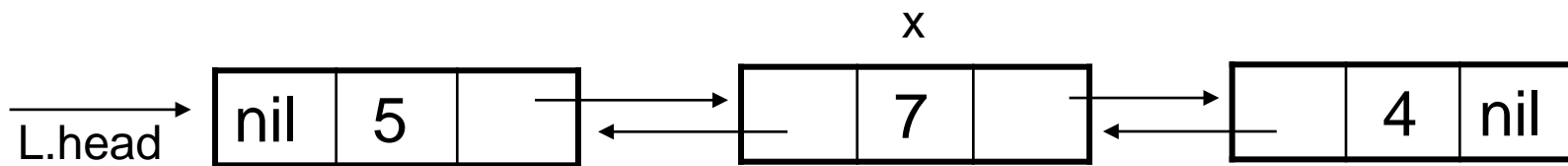

Linked Lists

List-Delete(L,x):

1. if $x.\text{prev} \neq \text{NIL}$ then
2. $x.\text{prev}.\text{next} := x.\text{next}$
3. else $L.\text{head} := x.\text{next}$
4. if $x.\text{next} \neq \text{NIL}$ then
5. $x.\text{next}.\text{prev} := x.\text{prev}$

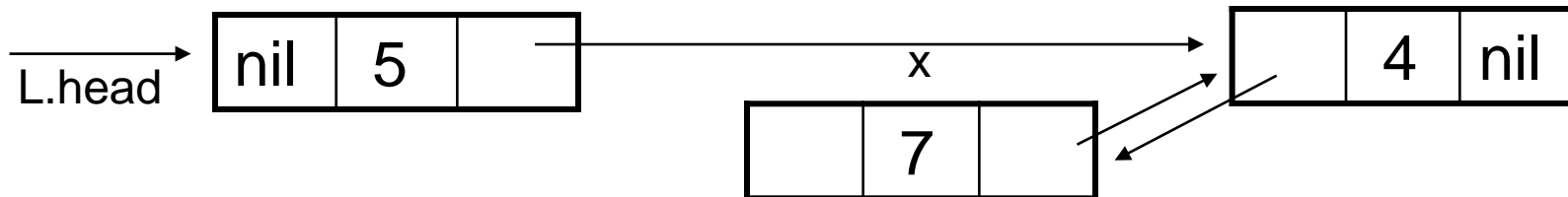

Linked Lists

List-Delete(L,x):

1. if $x.\text{prev} \neq \text{NIL}$ then
2. $x.\text{prev}.\text{next} := x.\text{next}$
3. else $L.\text{head} := x.\text{next}$
4. if $x.\text{next} \neq \text{NIL}$ then
5. $x.\text{next}.\text{prev} := x.\text{prev}$

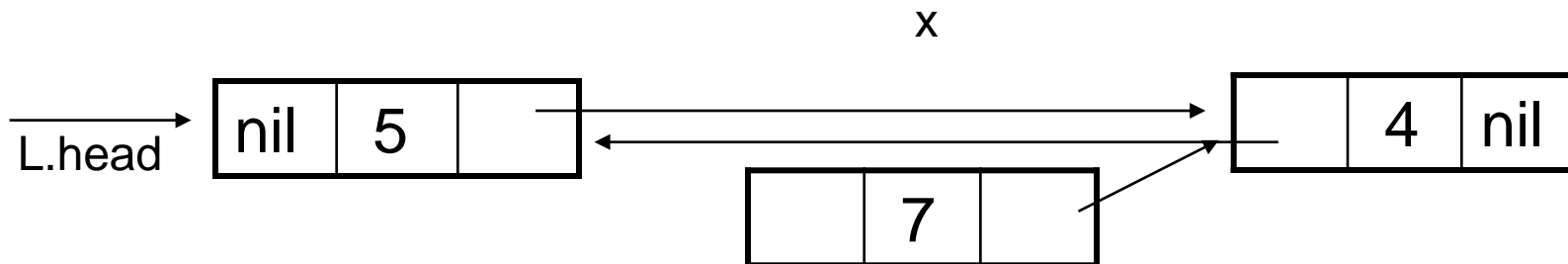

Overview

- Basic data structures
- Search structures (successor searching)
- Dictionaries (exact searching)

Search Structure

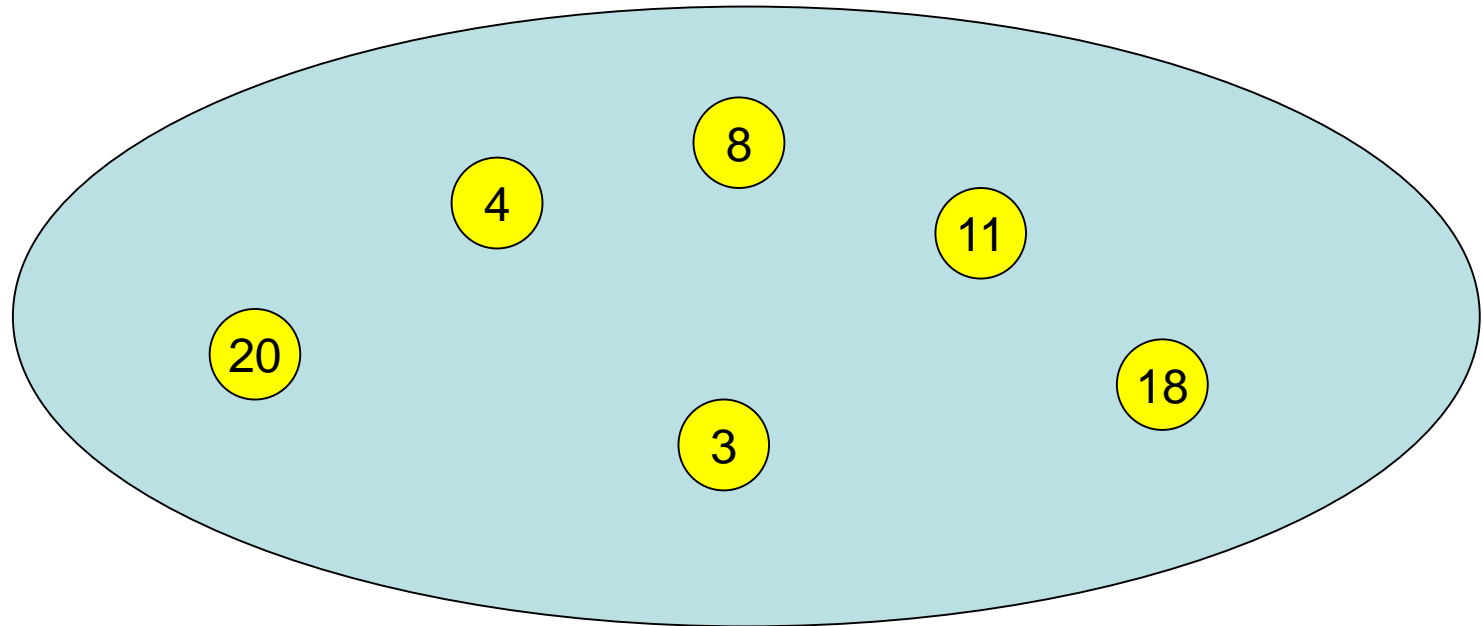

Search Structure

insert(15)

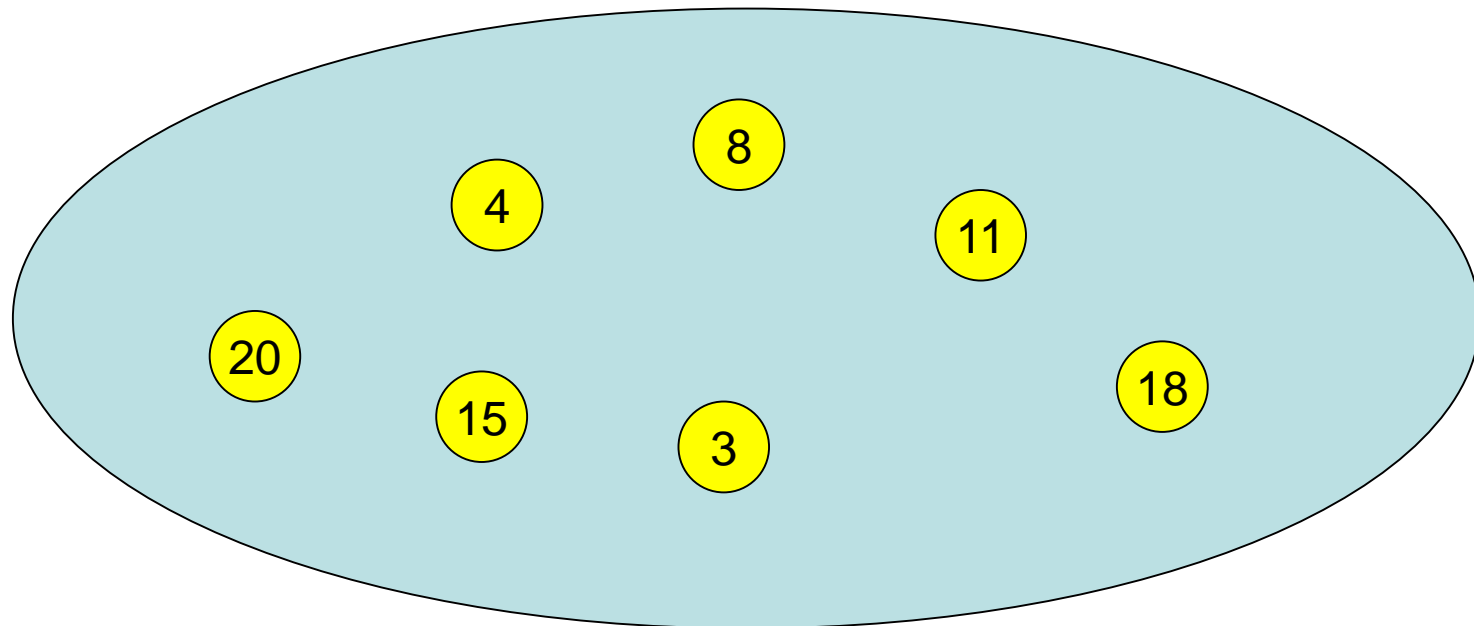

Search Structure

delete(20)

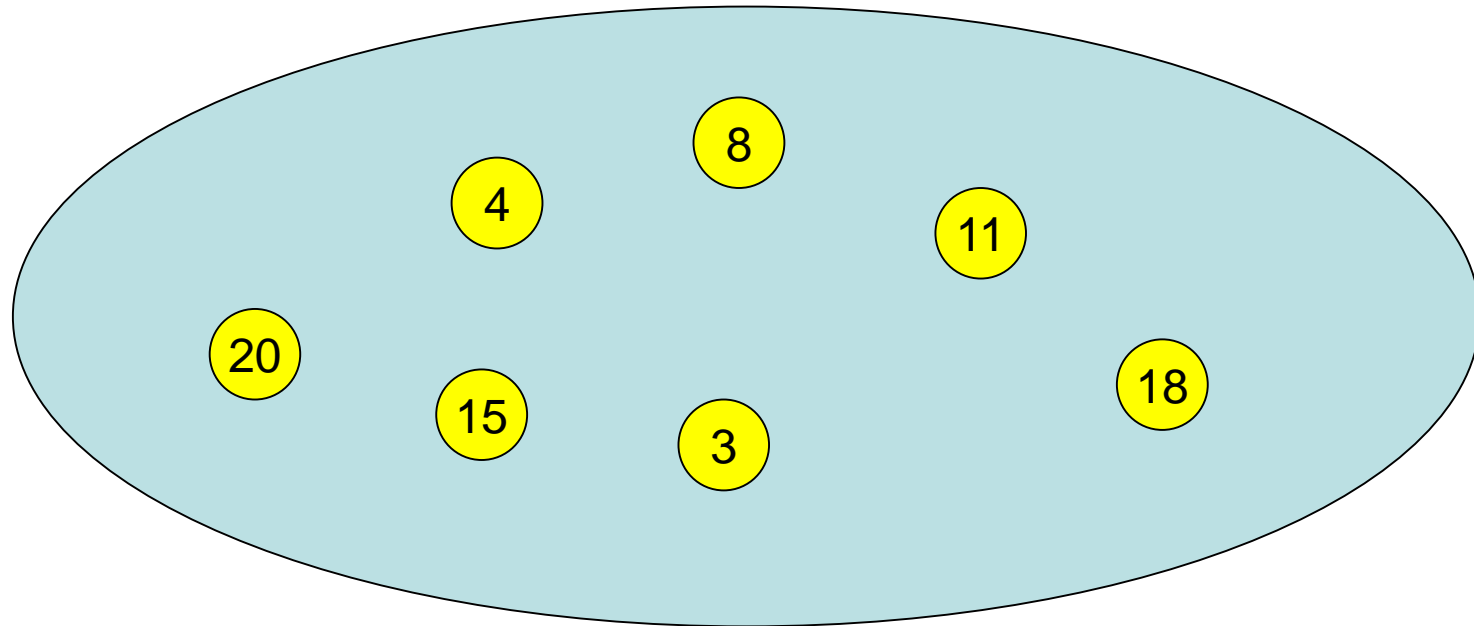

Search Structure

search(7) gives 8 (closest successor)

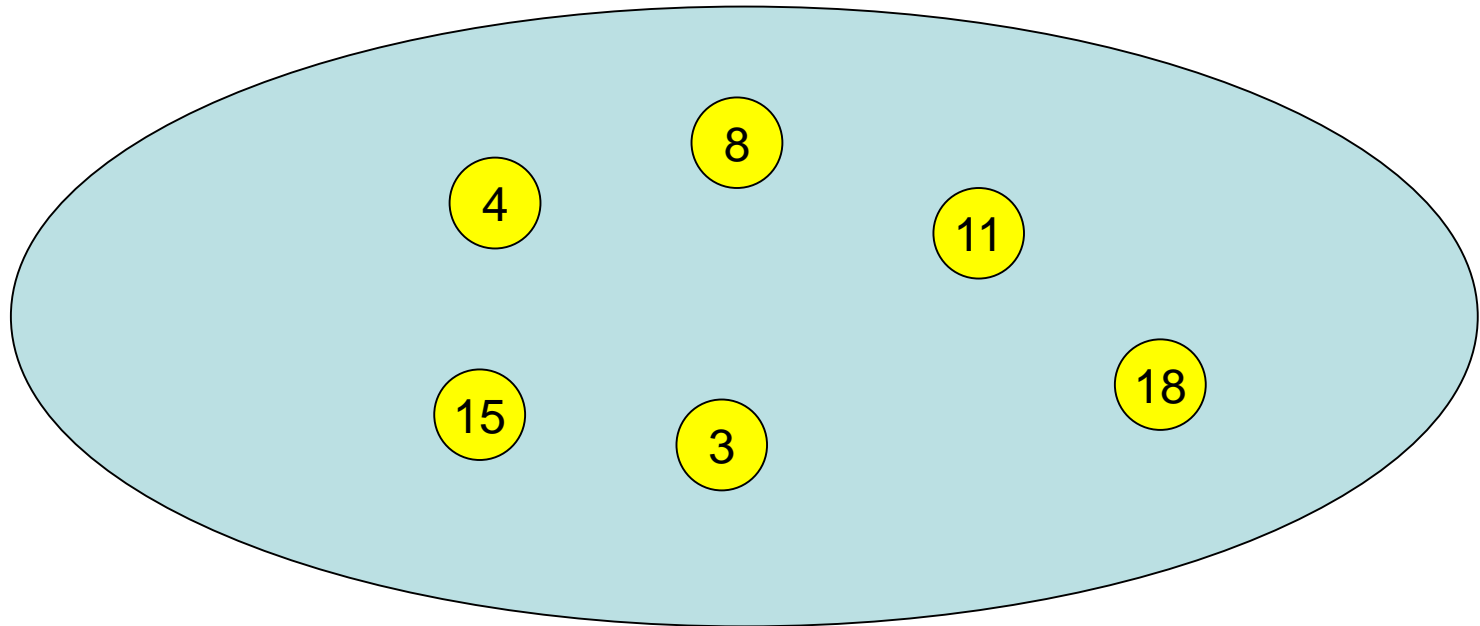

Search Structure

S: set of elements

Every element **e** identified by **key(e)**.

Operations:

- **S.insert**(**e**: Element): $S := S \cup \{e\}$
- **S.delete**(**k**: Key): $S := S \setminus \{e\}$, where **e** is the element with **key(e)=k**
- **S.search**(**k**: Key): outputs $e \in S$ with minimal **key(e)** so that **key(e) ≥ k**

Static Search Structure

1. Store elements in sorted array.

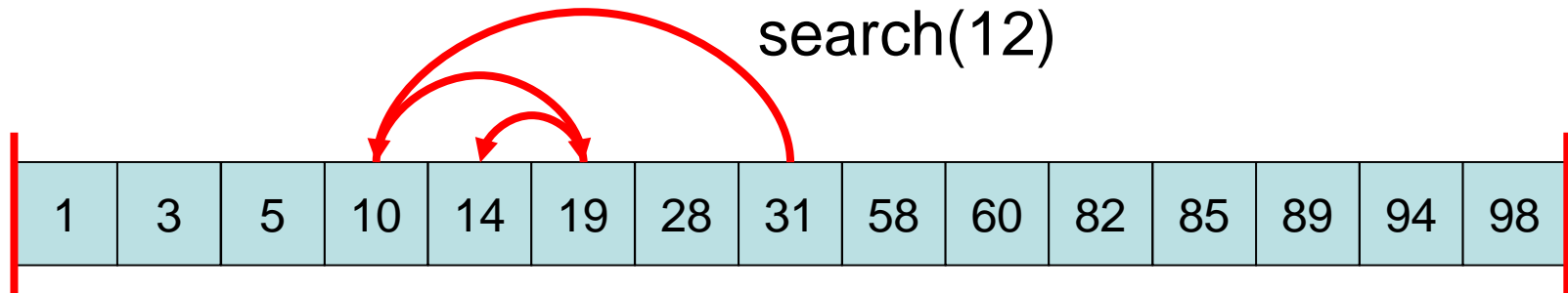

search: via binary search (in $O(\log n)$ time)

Binary Search

Input: number x and sorted array $A[1], \dots, A[n]$

Algorithm BinarySearch:

$l := 1; r := n$

while $l < r$ do

$m := (r+l) \text{ div } 2$

 if $A[m] = x$ then return m

 if $A[m] < x$ then $l := m+1$

 else $r := m$

return l

Dynamic Search Structure

insert und delete Operations:

Sorted array difficult to update!

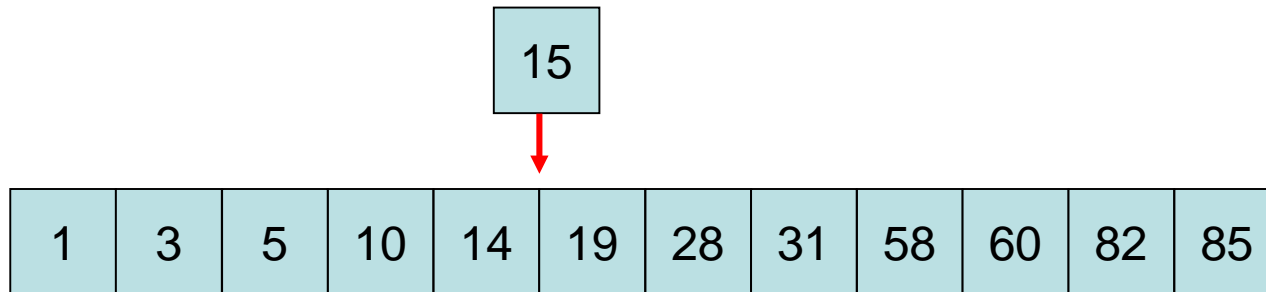

Worst case: $\Theta(n)$ time

Search Structure

2. Sorted List (with an ∞ -Element)

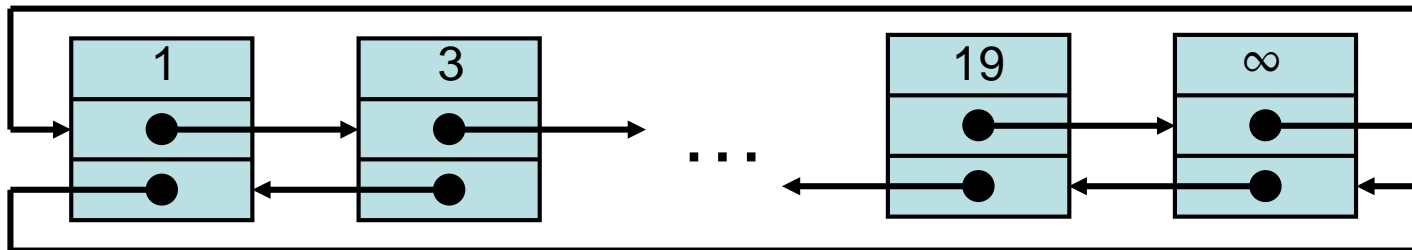

Problem: insert, delete and search take $\Theta(n)$ time in the worst case

Observation: If search could be implemented efficiently, then also all other operations

Search Structure

Idee: add navigation structure that allows **search** to run efficiently

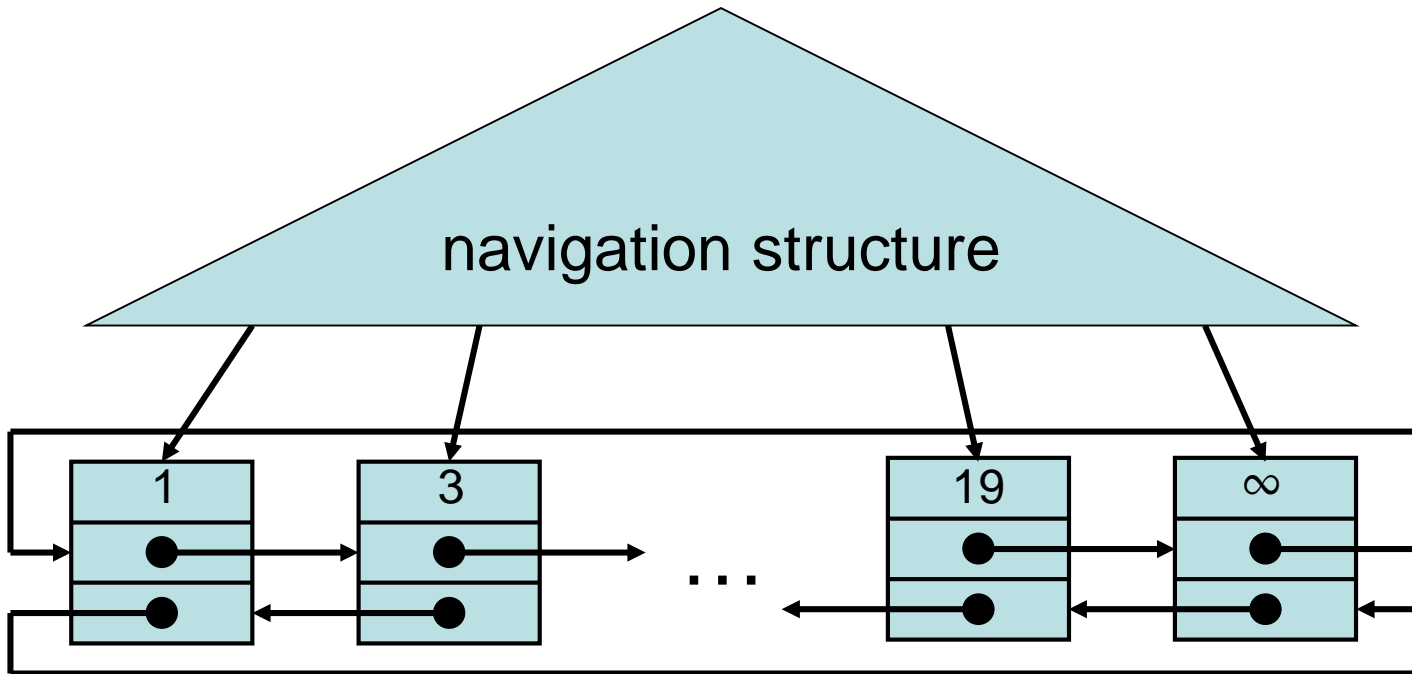

Binary Search Tree (ideal)

search(12)

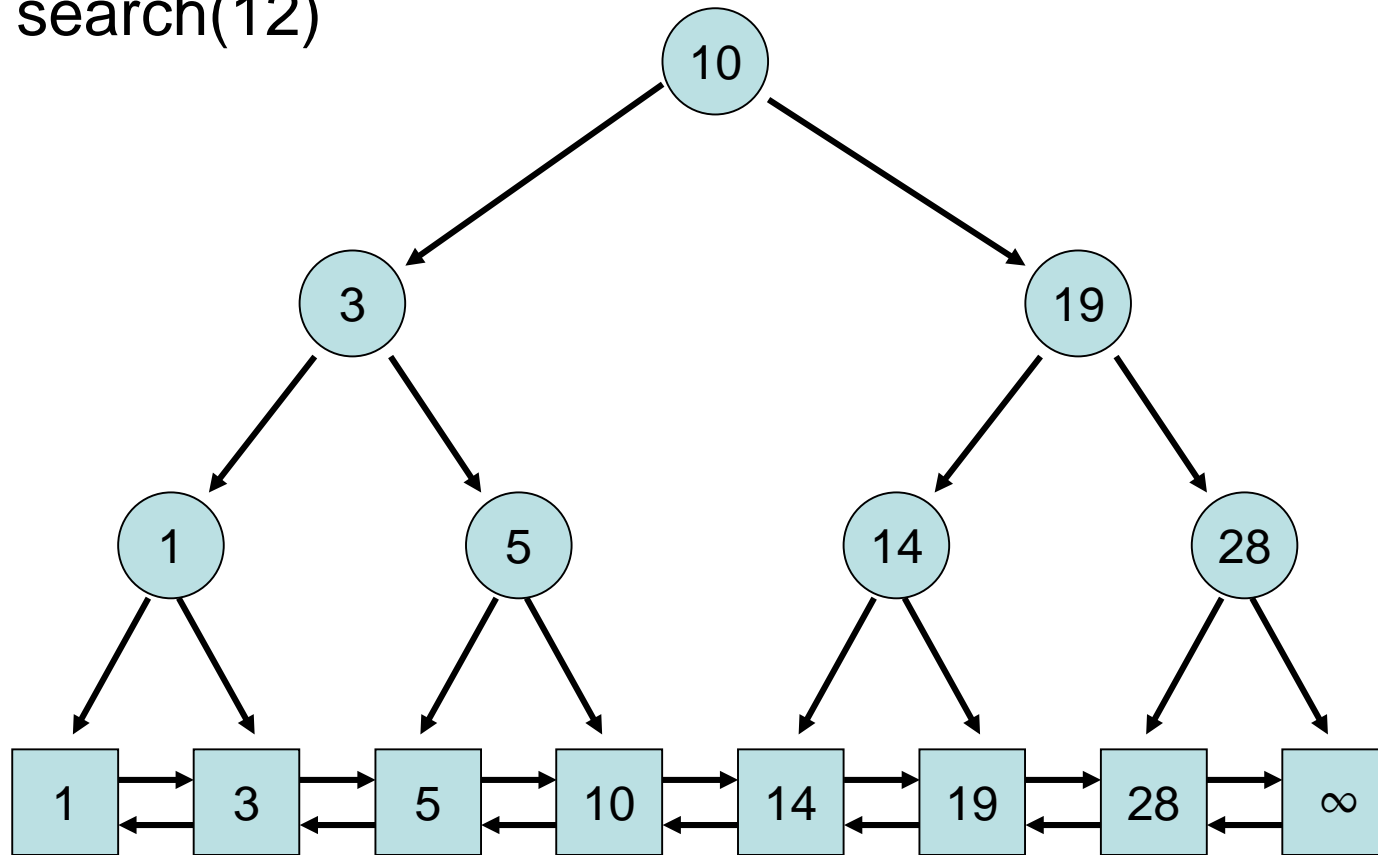

Binary Search Tree

Search tree invariant:

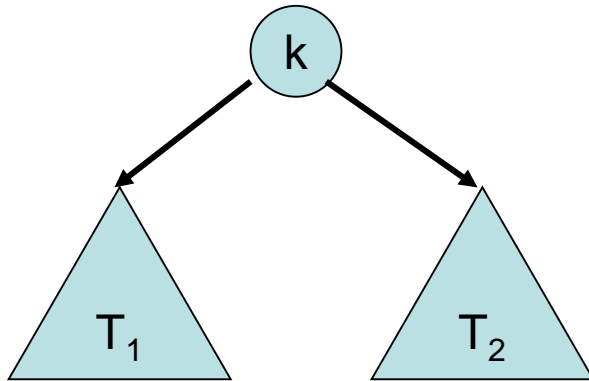

For **all** keys k' in T_1 and k'' in T_2 : $k' \leq k < k''$

Binary Search Tree

Formally: for every tree node v let

- $\text{key}(v)$ be the key stored at v
- $d(v)$ the number of children of v
- **Search tree invariant:** (as above)
- **Degree invariant:**
All tree nodes have exactly two children
(as long as the number of elements in the list is >1)
- **Key invariant:**
For every element e in the list there is exactly one tree node v with $\text{key}(v)=\text{key}(e)$.

Binary Search Tree

- **Search tree invariant:** (as before)
- **Degree invariant:**
All tree nodes have exactly two children
(as long as the number of elements is >1)
- **Key invariant:**
For every element e in the list there is exactly one tree node v with $\text{key}(v)=\text{key}(e)$.

From the search tree and key invariants it follows that for every left subtree T of a node v , the rightmost list element e under T satisfies $\text{key}(v)=\text{key}(e)$.

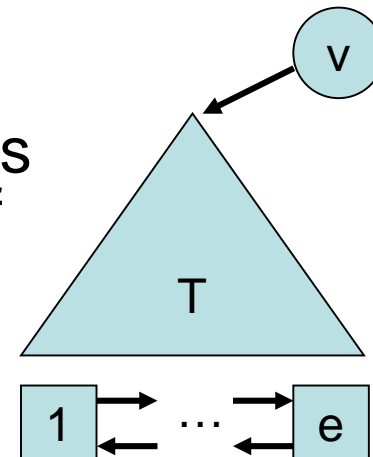

search(x) Operation

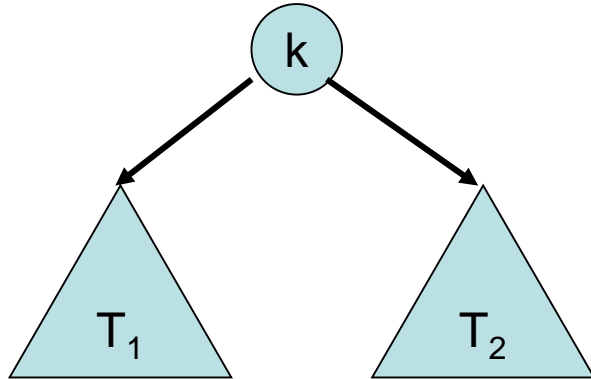

For all keys k' in T_1 and k'' in T_2 : $k' \leq k < k''$

Search strategy:

- Start at the root, v , of the search tree
- while v is a tree node:
 - if $x \leq \text{key}(v)$ then let v be the left child of v ,
otherwise let v be the right child of v
- Output (list node) v

search(x) Operation

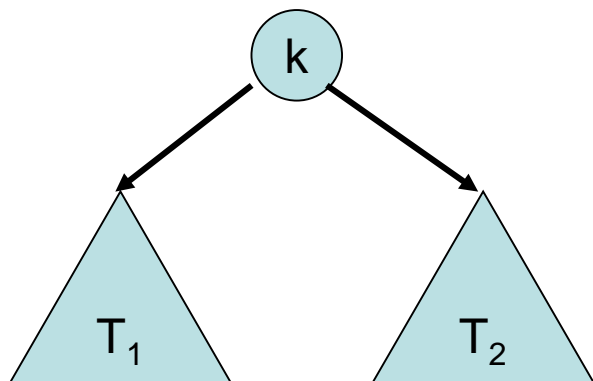

For **all** keys k' in T_1 and k'' in T_2 : $k' \leq k < k''$

Correctness of search strategy:

- For every left subtree T of a node v , the rightmost list element e under T satisfies $\text{key}(v) = \text{key}(e)$.
- So whenever $\text{search}(x)$ enters T , there is an element e in the list below T with $\text{key}(e) \geq x$.

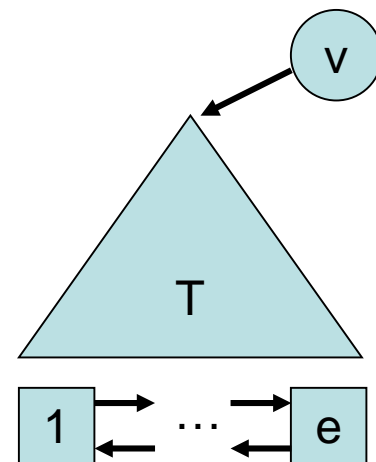

Search(9)

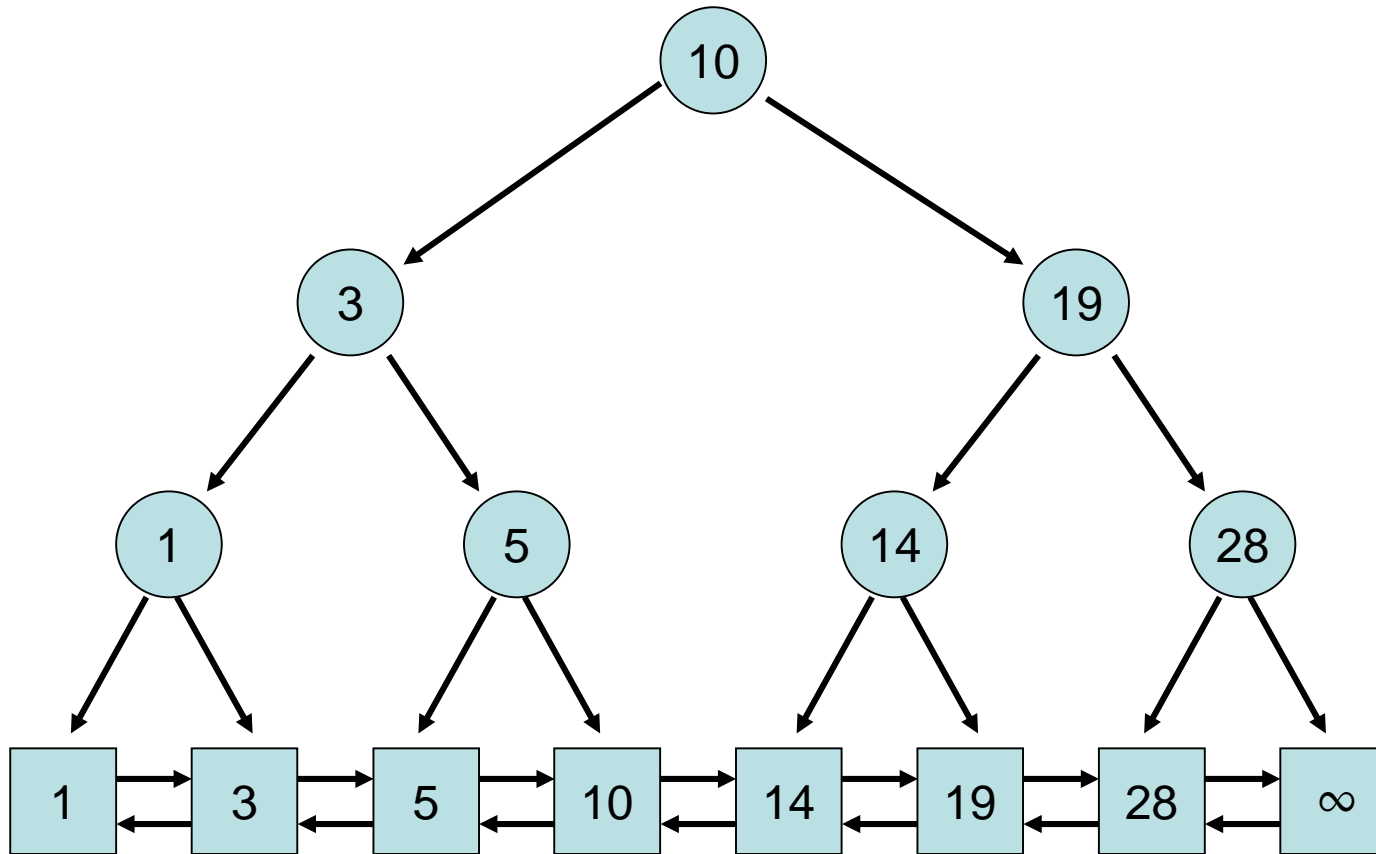

Insert and Delete Operations

Strategy:

- **insert(e):**
First, execute **search(key(e))** to obtain a list element e' .
If **key(e)=key(e')**, replace e' by e , otherwise insert e between e' and its predecessor in the list and add a new search tree leaf for e and e' with key **key(e)**.
- **delete(k):**
First, execute **search(k)** to obtain a list element e . If **key(e)= k** , then delete e from the list and the parent v of e from the search tree, and set in the tree node w with **key(w)= k : key(w):=key(v)**.

Insert(5)

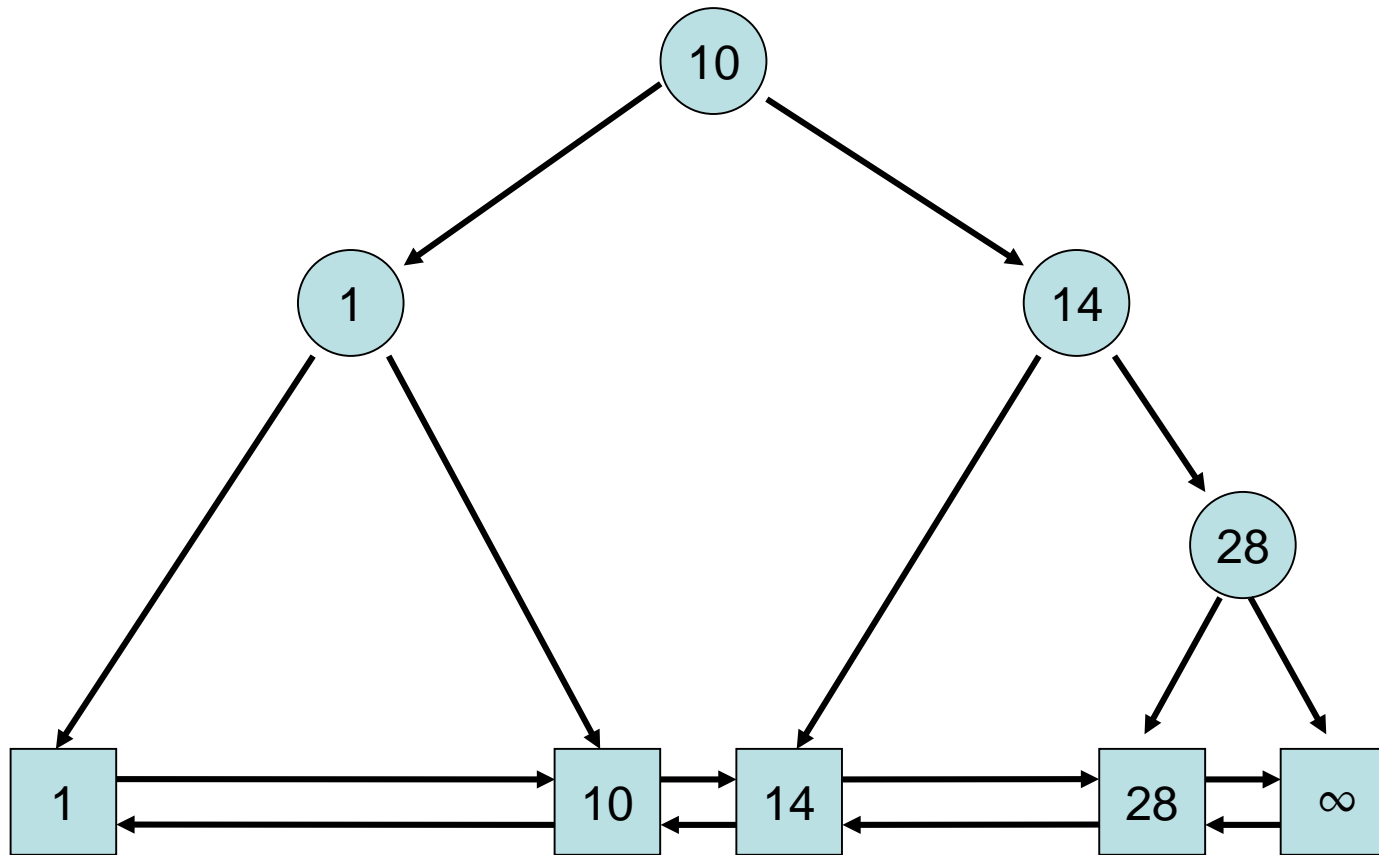

Insert(5)

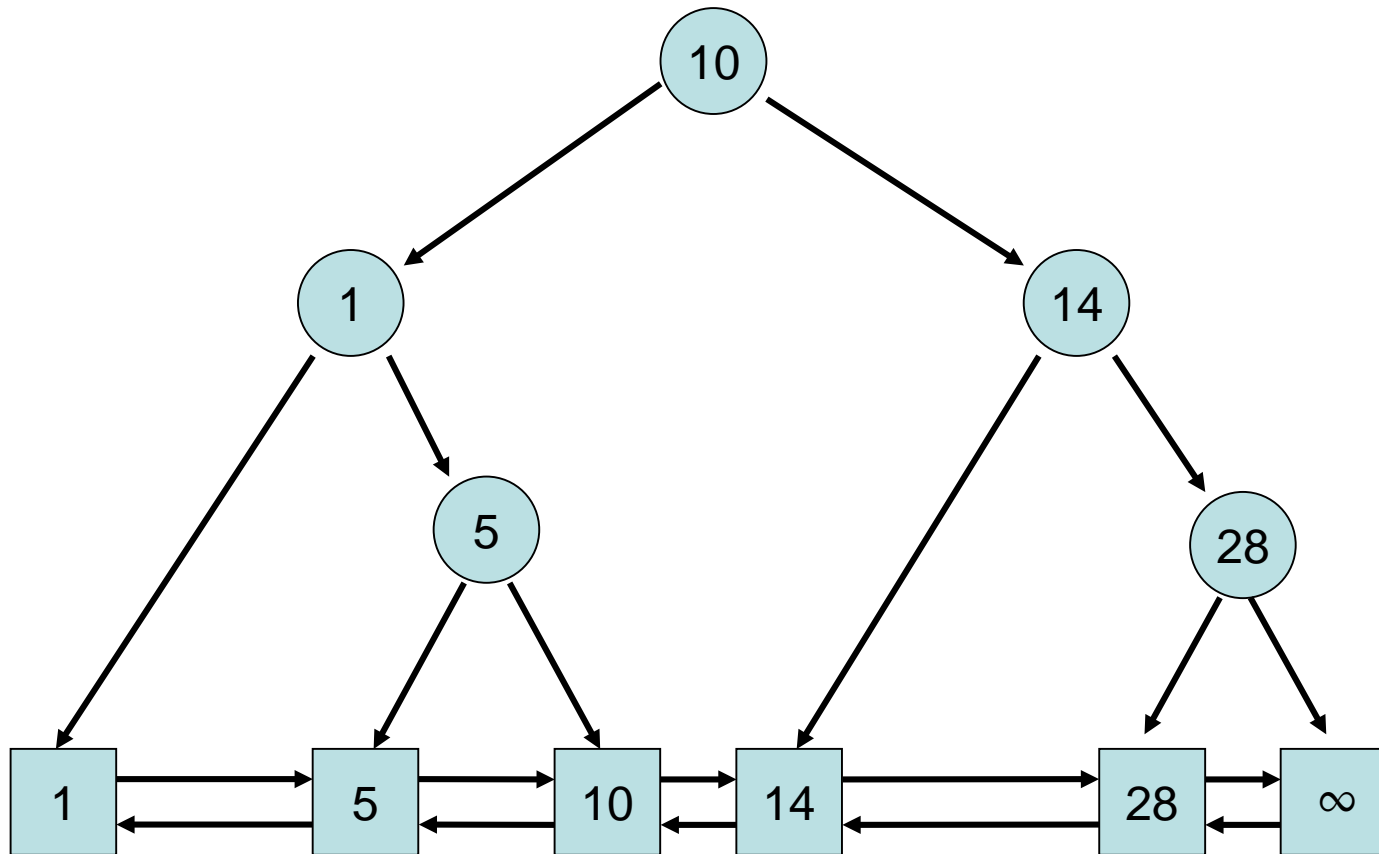

Insert(12)

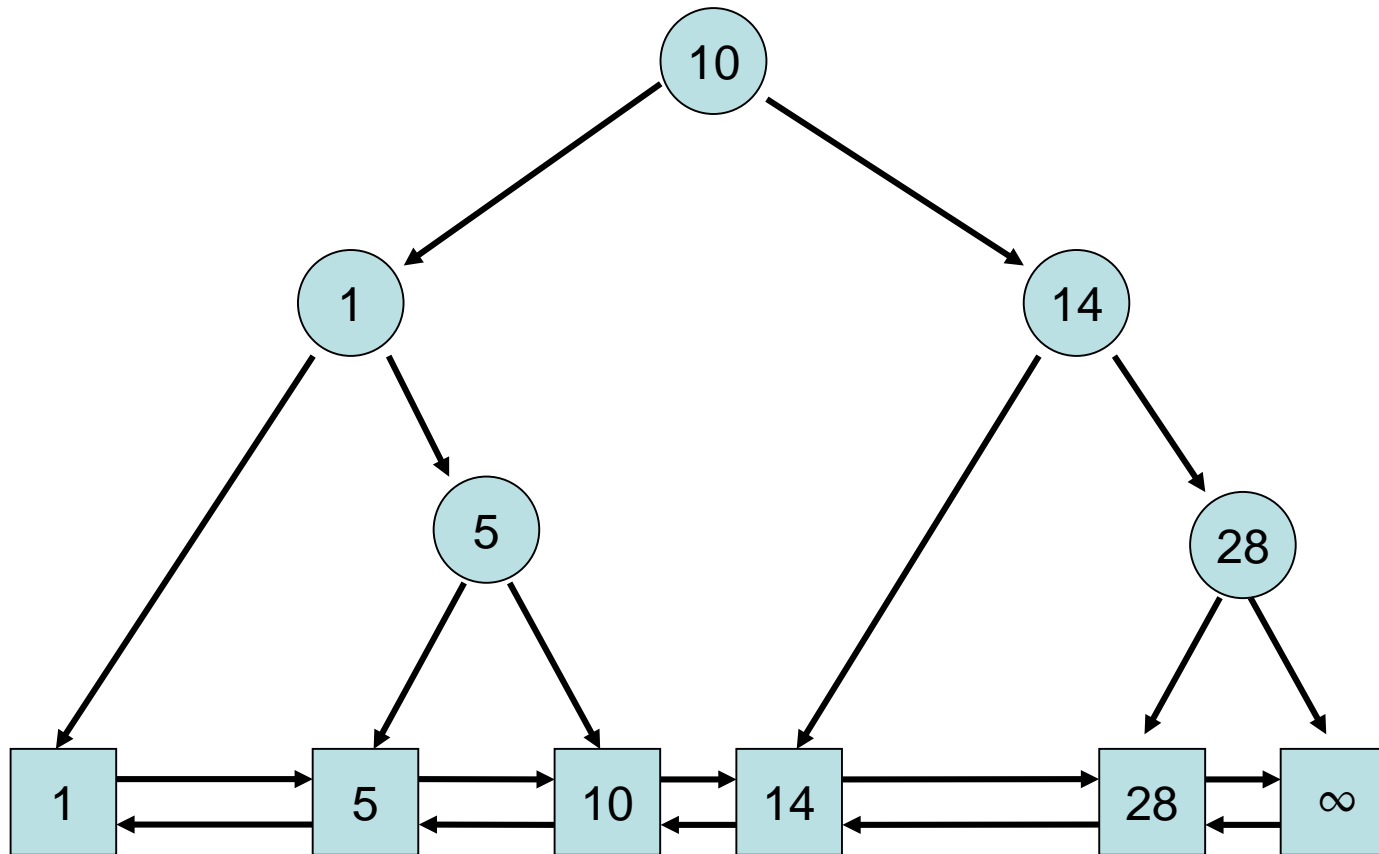

Insert(12)

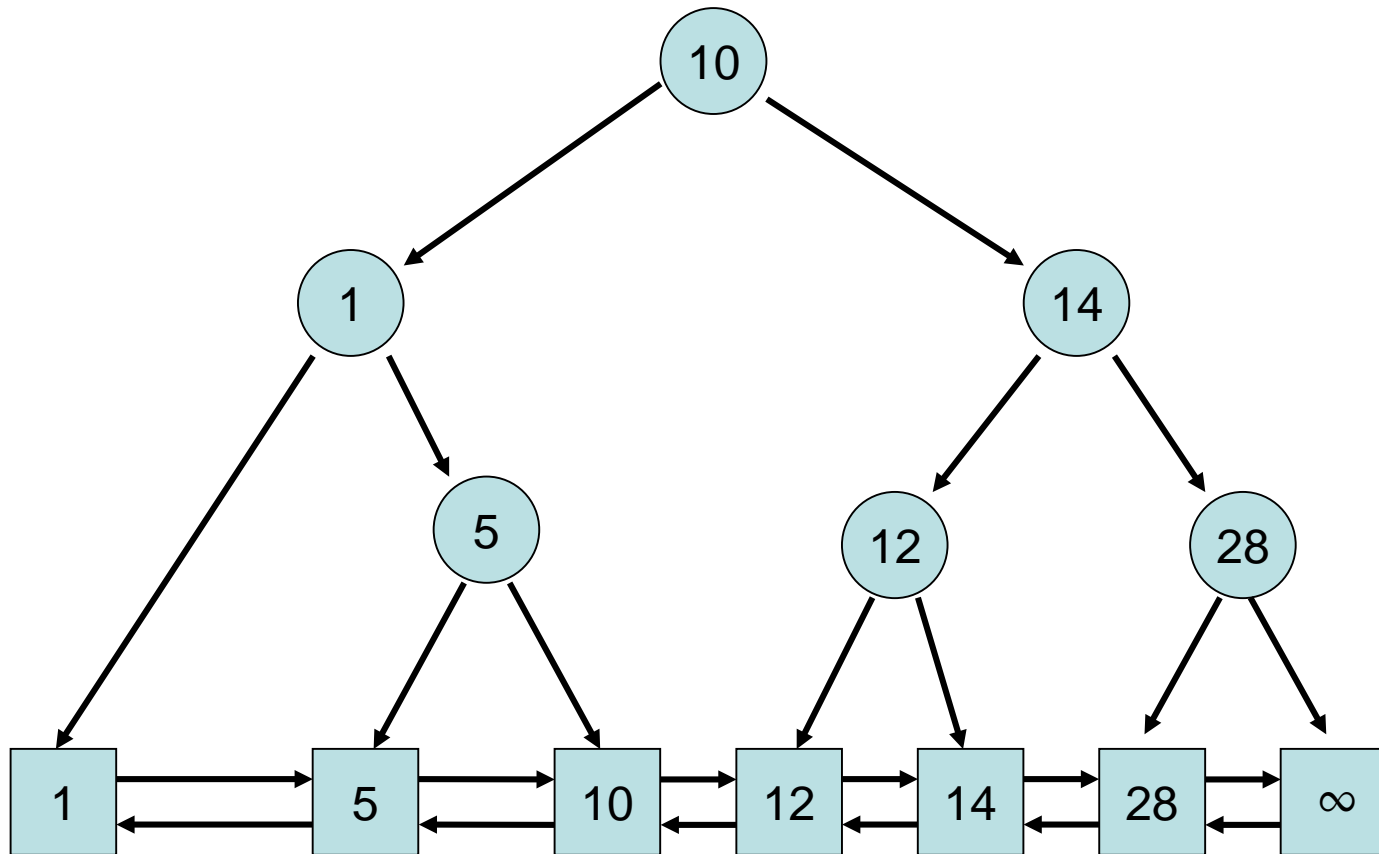

Delete(1)

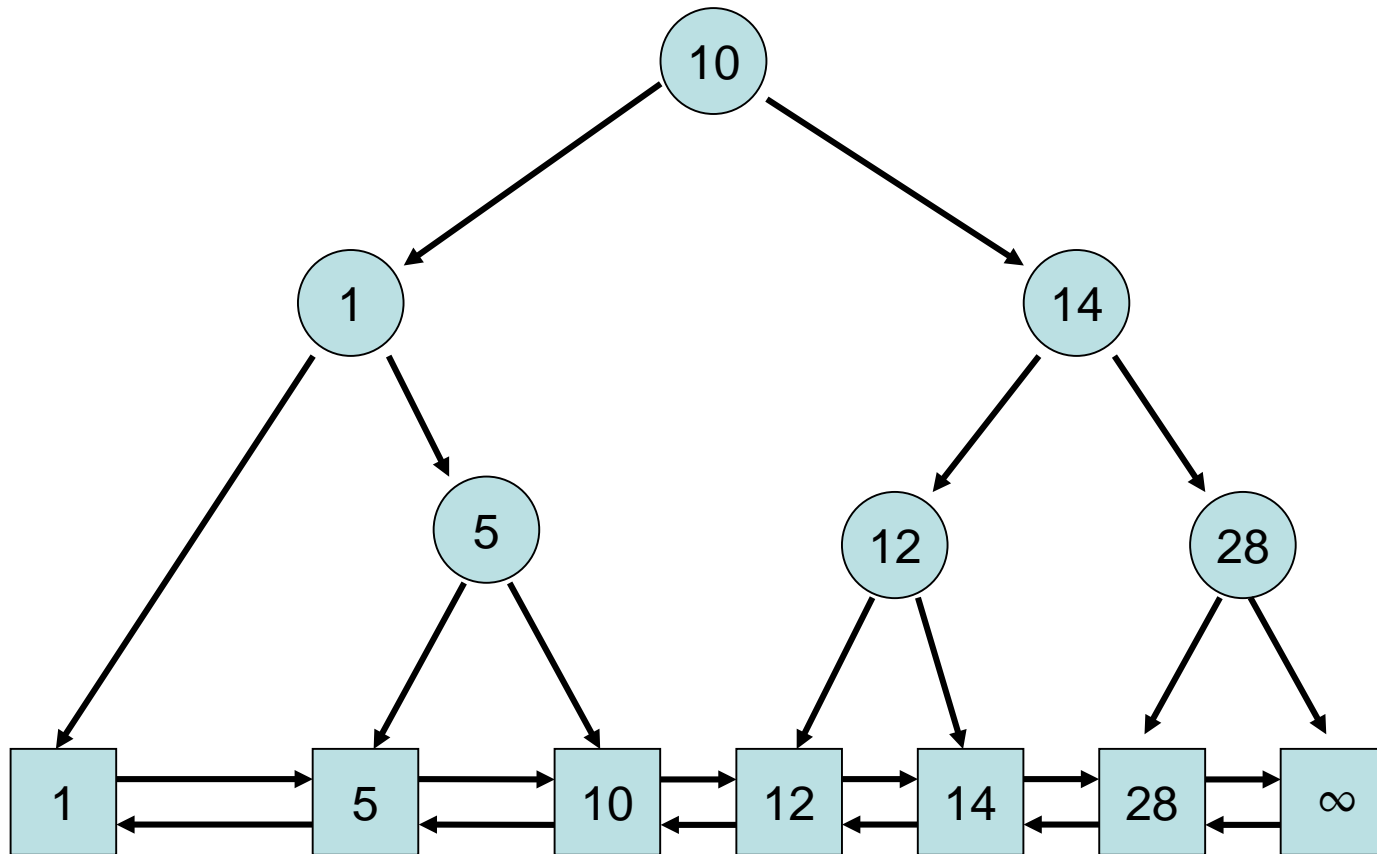

Delete(1)

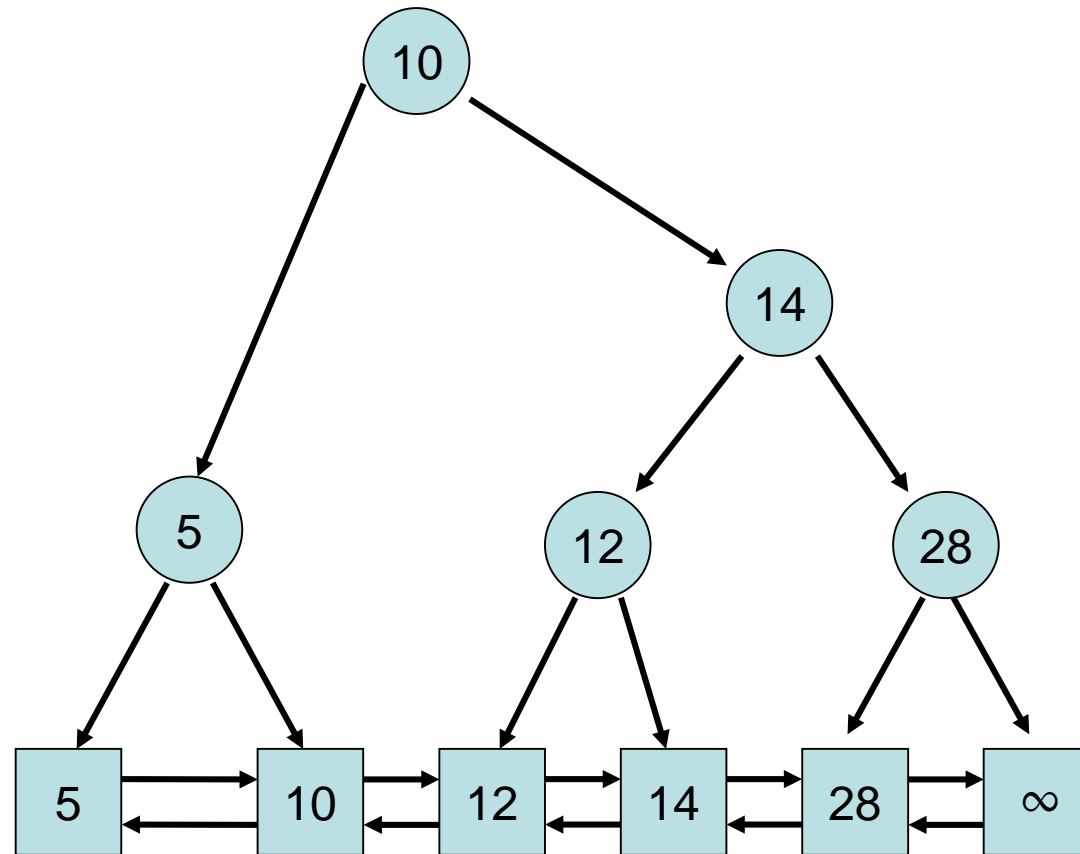

Delete(14)

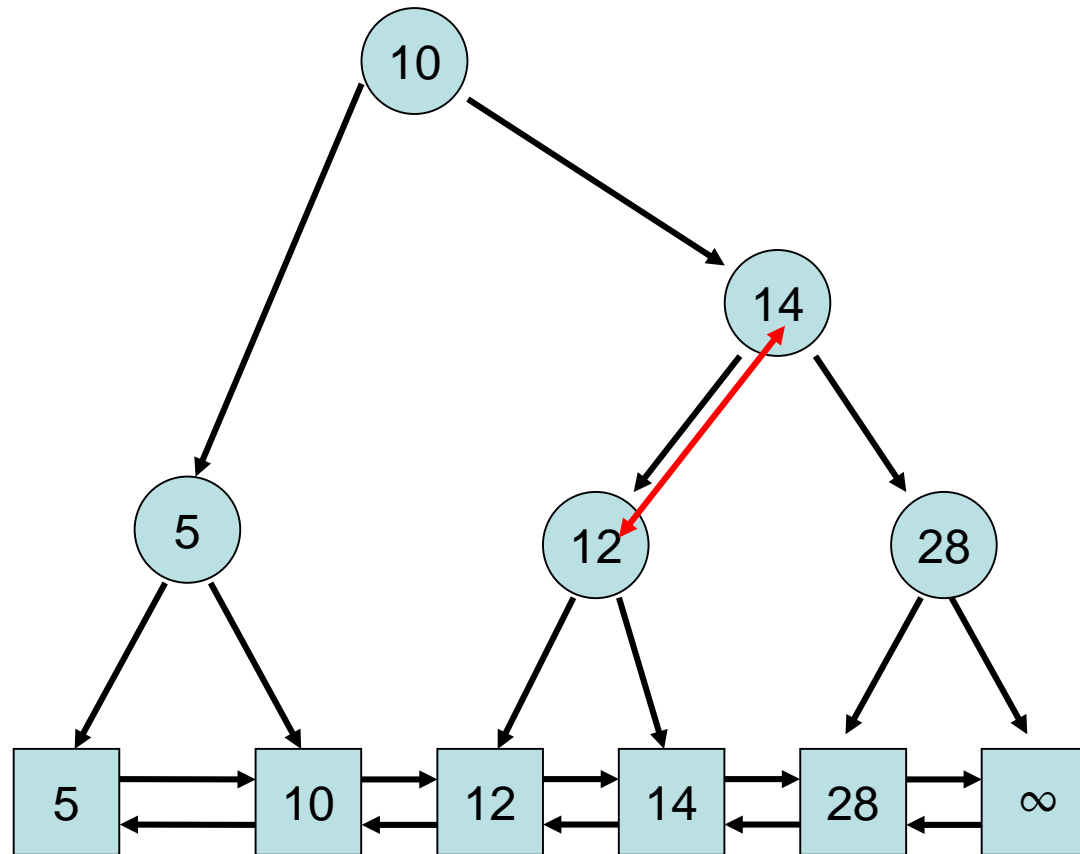

Delete(14)

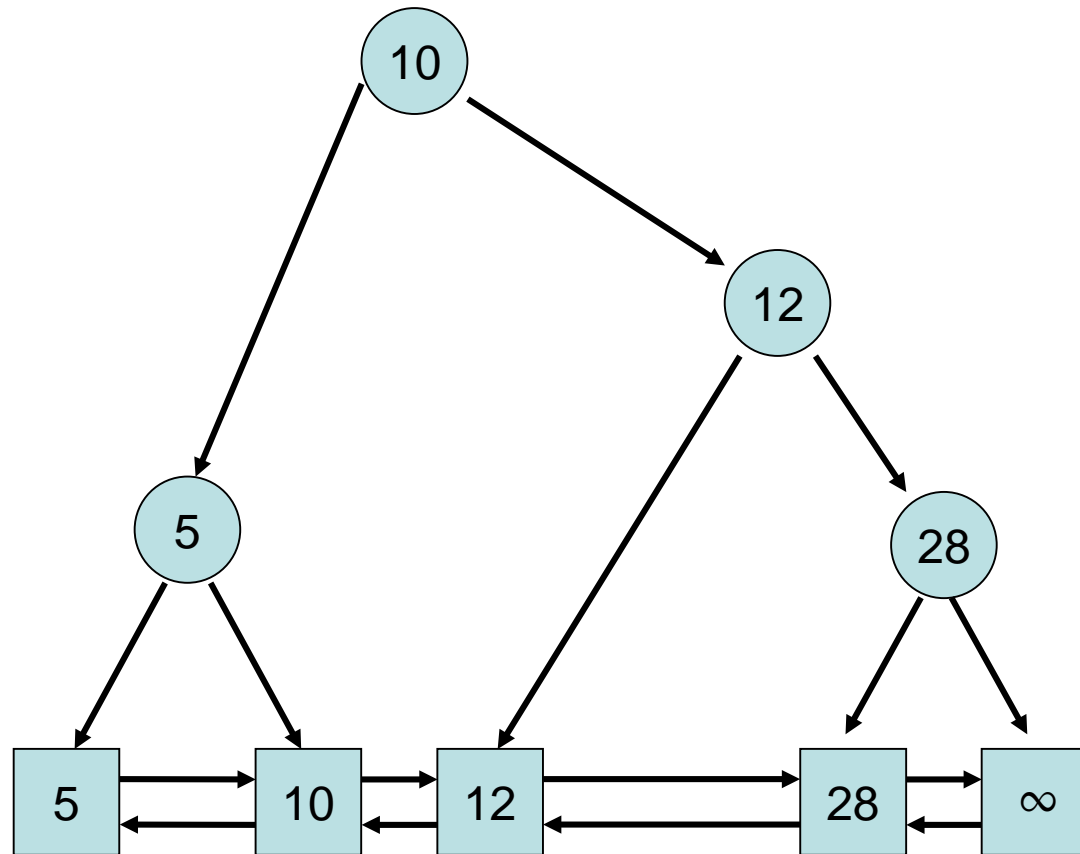

Binary Search Tree

Problem: binary tree can degenerate!

Example: numbers are inserted in sorted order

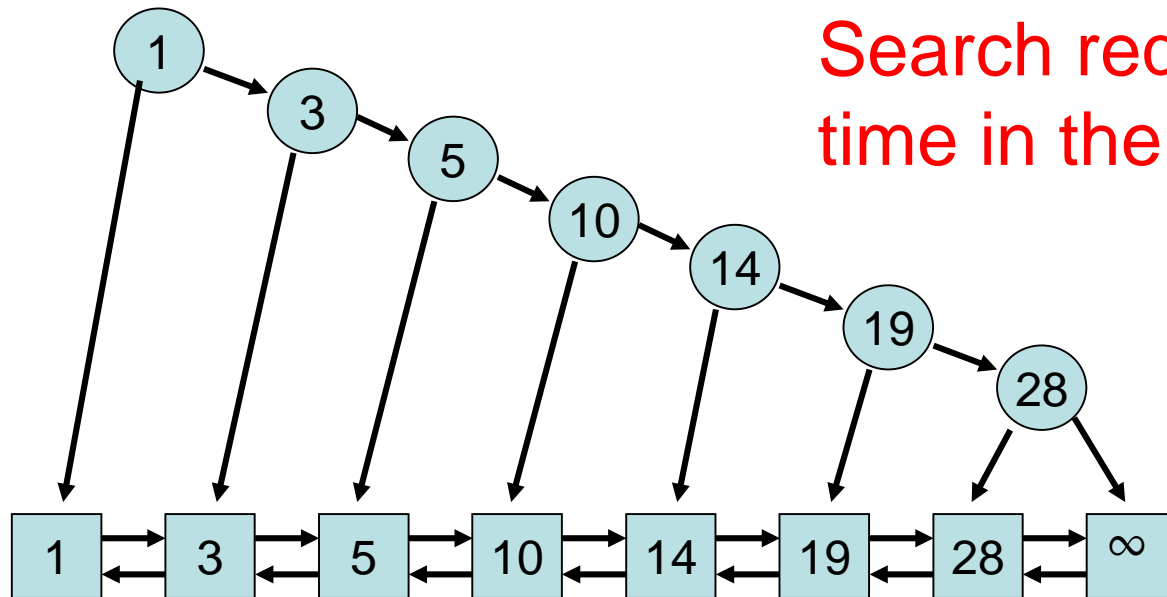

Search requires $\Theta(n)$
time in the worst case

Search Trees

Problem: binary tree can degenerate!

Solution:

- (a,b)-tree
(guaranteed well balanced)

(a,b)-Trees

Problem: how to maintain a balanced search tree

Idea:

- All nodes v (except for the root) have degree $d(v)$ with $a \leq d(v) \leq b$, where $a \geq 2$ and $b \geq 2a - 1$ (otherwise this cannot be enforced)
- All leaves have the **same** depth

→ **(a,b)-trees**, which are a general form of **B-trees** (see Chapter 18).

(a,b)-Trees

Formally: for a tree node v let

- $d(v)$ be the number of children of v
- $t(v)$ be the depth of v (root has depth 0)

- **Form Invariant:**
For all leaves v, w : $t(v) = t(w)$

- **Degree Invariant:**
For all inner nodes v
except for root: $d(v) \in [a, b]$,
for root r : $d(r) \in [2, b]$
(as long as #elements > 1)

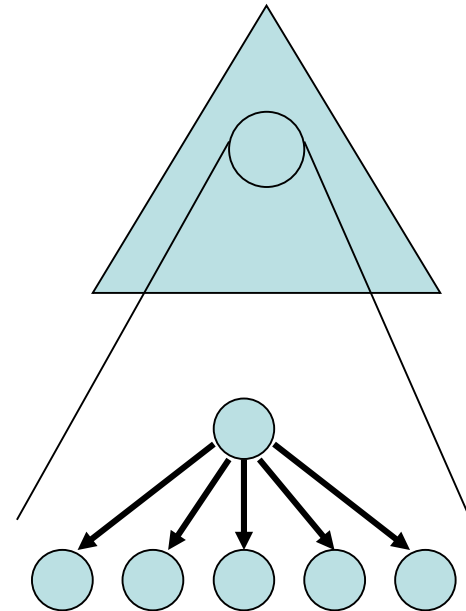

(a,b)-Trees

Lemma 3.10: An (a,b)-tree with n elements has depth at most $1 + \lfloor \log_a (n+1)/2 \rfloor$

Proof:

- The root has degree ≥ 2 and every other inner node has degree $\geq a$.
- At depth t there are at least $2a^{t-1}$ nodes
- $n+1 \geq 2a^{t-1} \Leftrightarrow t \leq 1 + \lfloor \log_a (n+1)/2 \rfloor$

(a,b)-Trees

(a,b)-Tree-Rule:

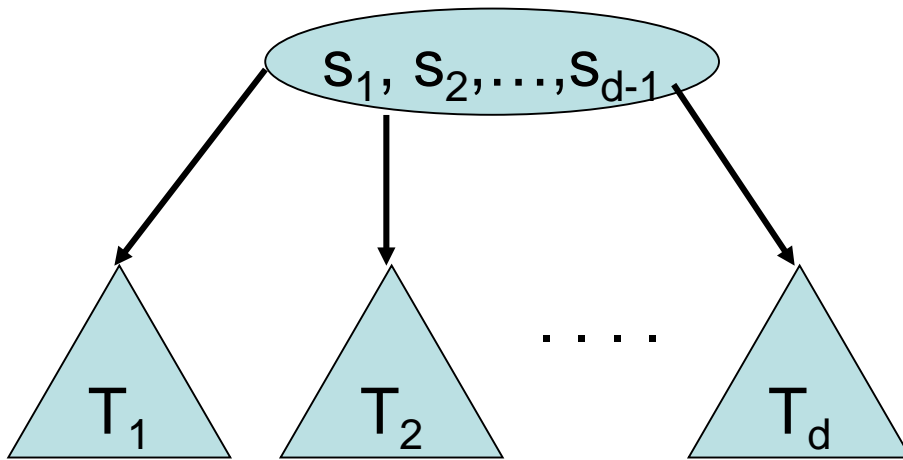

For all keys k in T_i and k' in T_{i+1} : $k \leq s_i < k'$

Then **search** operation easy to implement.

Search(9)

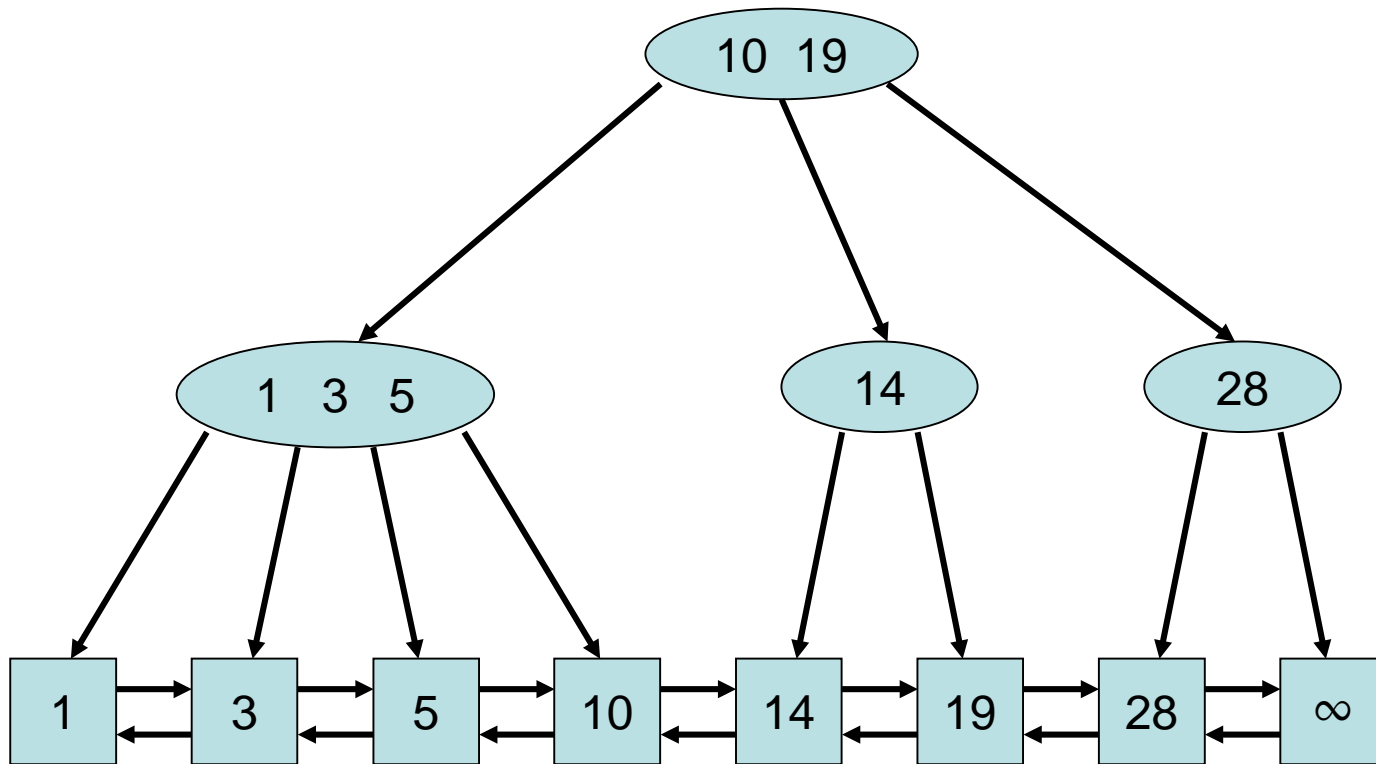

Insert(e) Operation

Strategy:

- First $\text{search}(\text{key}(e))$ until some e' found in the list. If $\text{key}(e') > \text{key}(e)$, insert e in front of e' , otherwise replace e' by e .

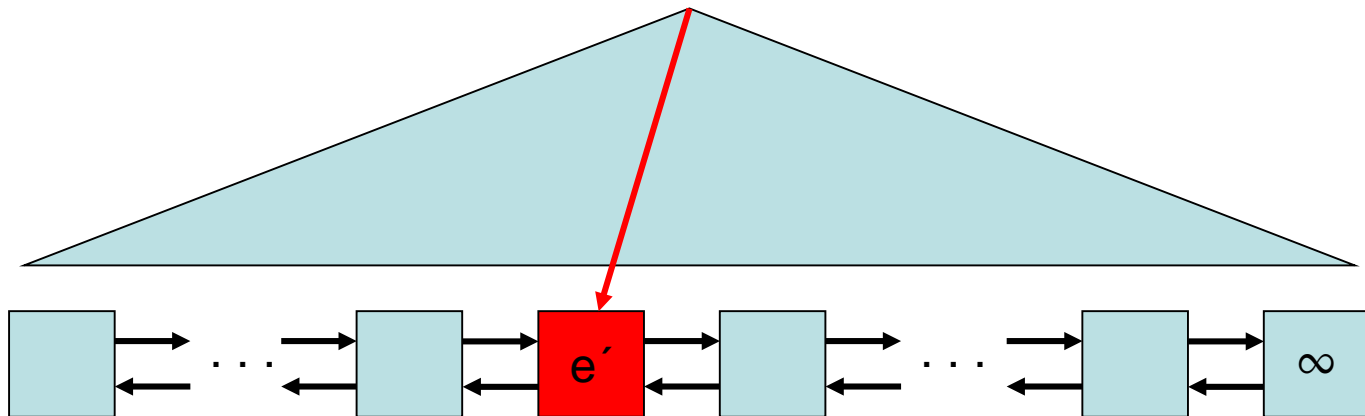

Insert(e) Operation

Strategy:

- First $\text{search}(\text{key}(e))$ until some e' found in the list. If $\text{key}(e') > \text{key}(e)$, insert e in front of e' , otherwise replace e' by e .

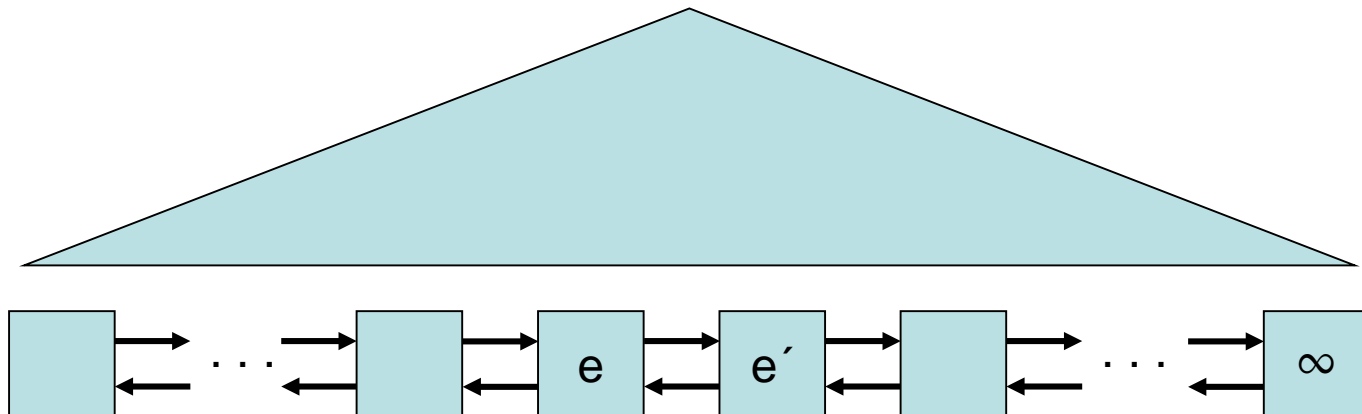

Insert(e) Operation

- Add $\text{key}(e)$ and pointer to e in tree node v above e' . If we still have $d(v) \in [a, b]$ afterwards, then we are done.

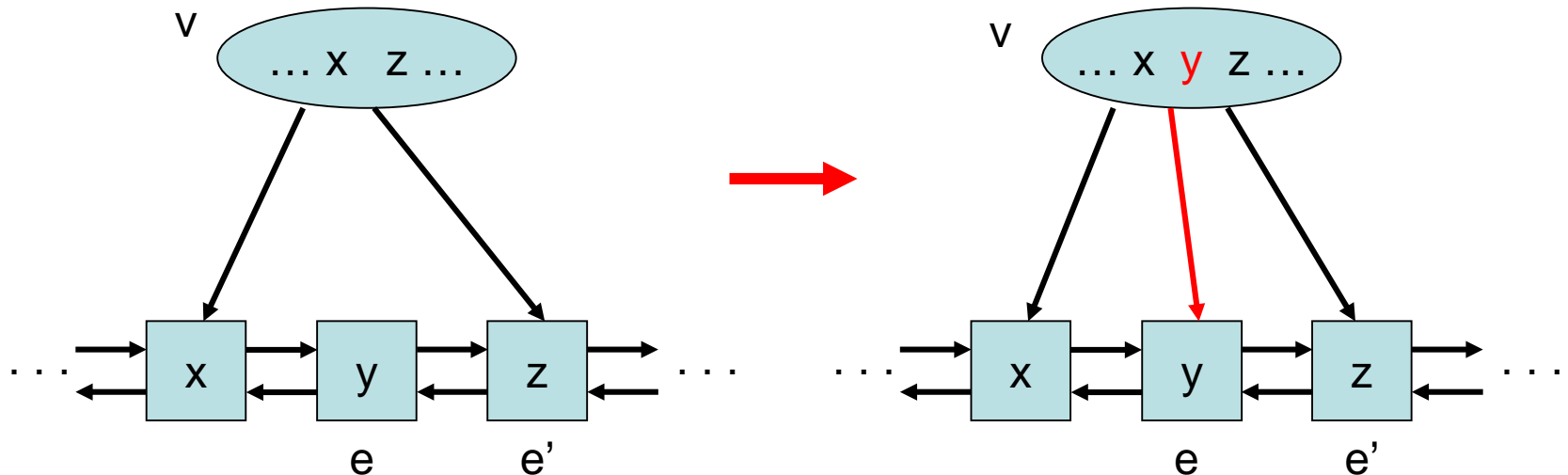

Insert(e) Operation

- If $d(v) > b$, then cut v into two nodes.
(Example: $a=2$, $b=4$)

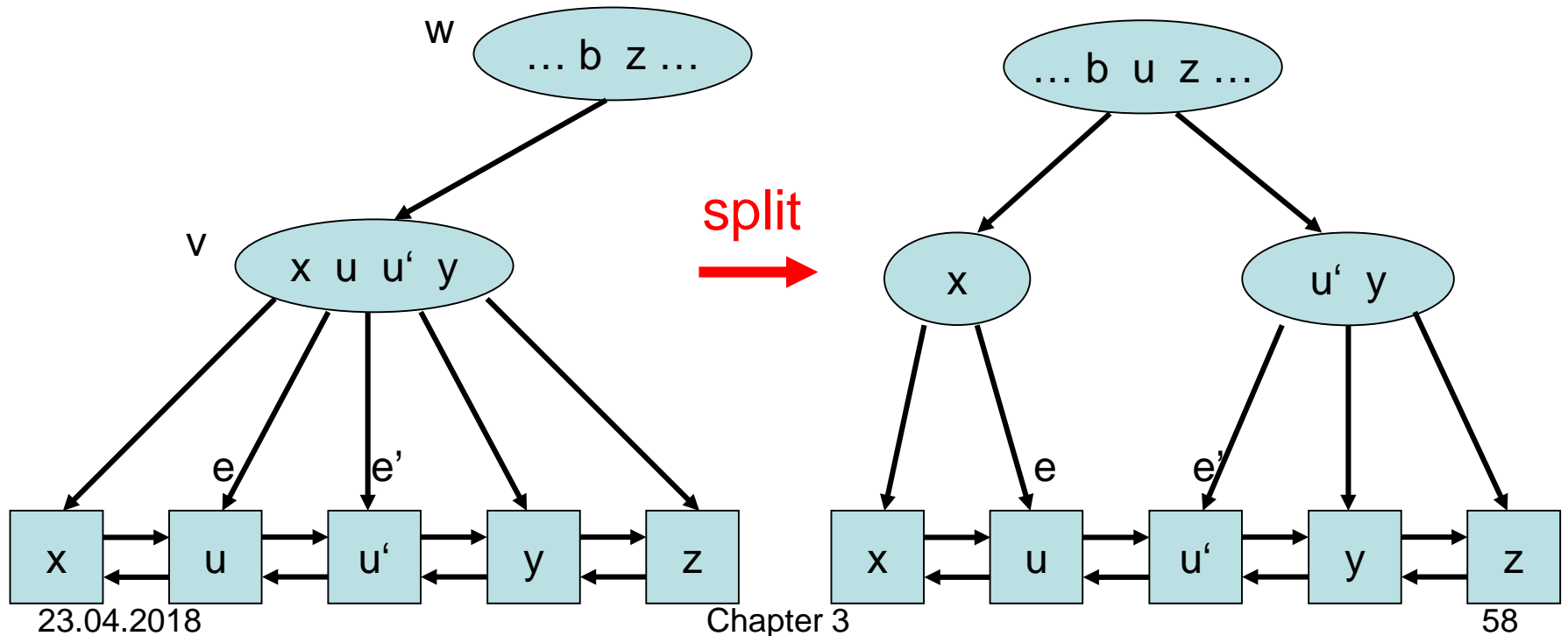

Insert(e) Operation

- If after splitting v , $d(w) > b$, then cut w into two nodes (and so on, until all nodes have degree $\leq b$ or we reached the root)

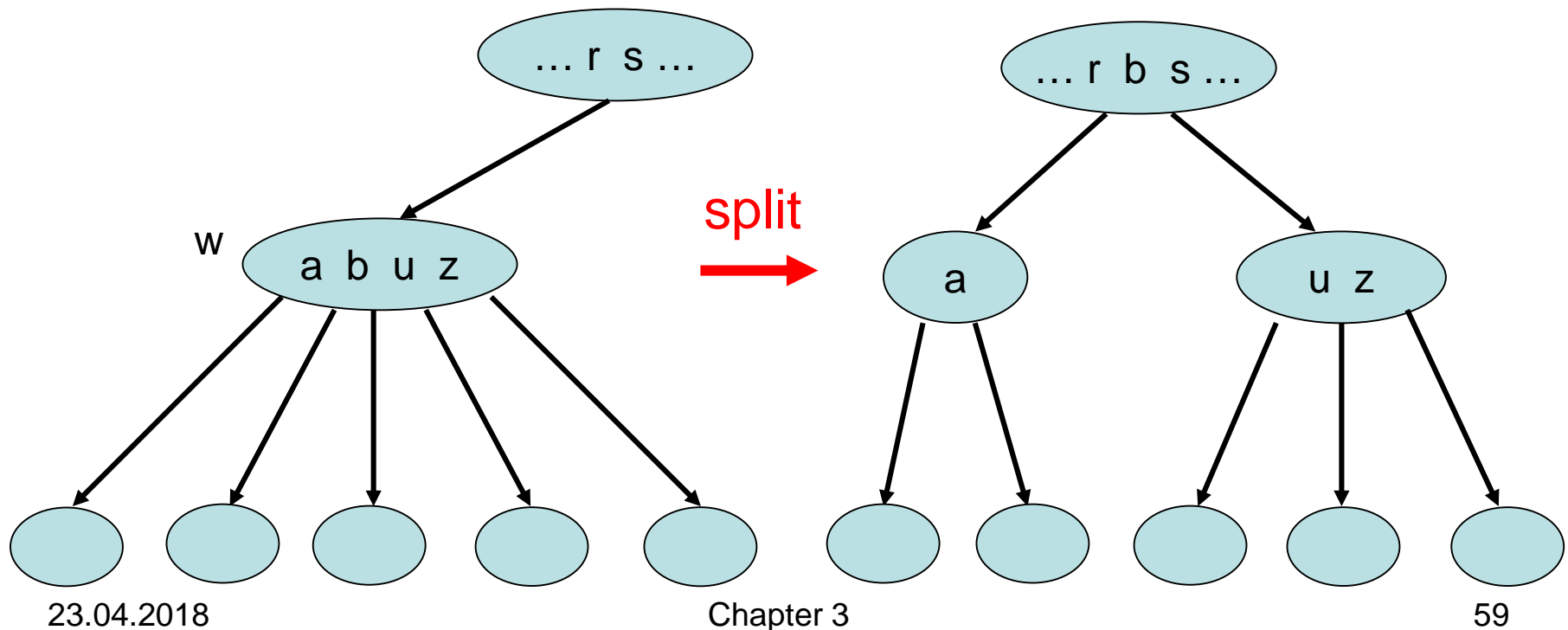

Insert(e) Operation

- If for the root v of T , $d(v) > b$, then cut v into two nodes and create a new root node.

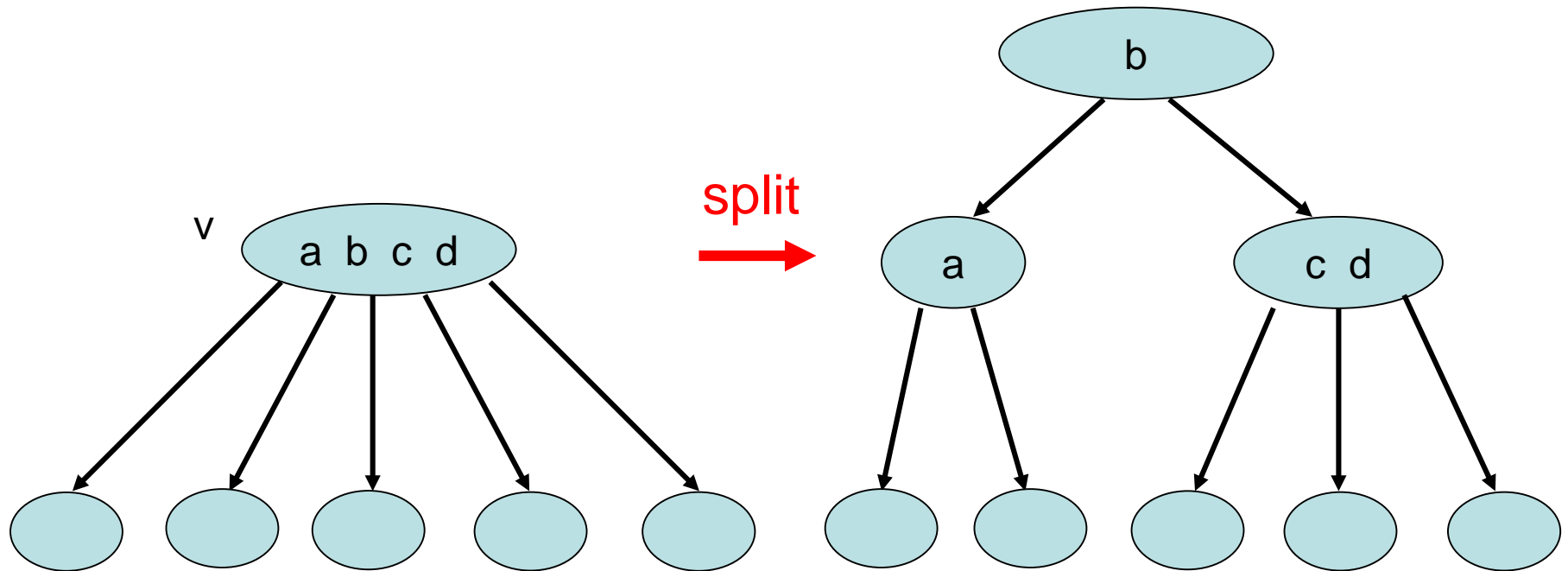

Insert(8)

a=2, b=4

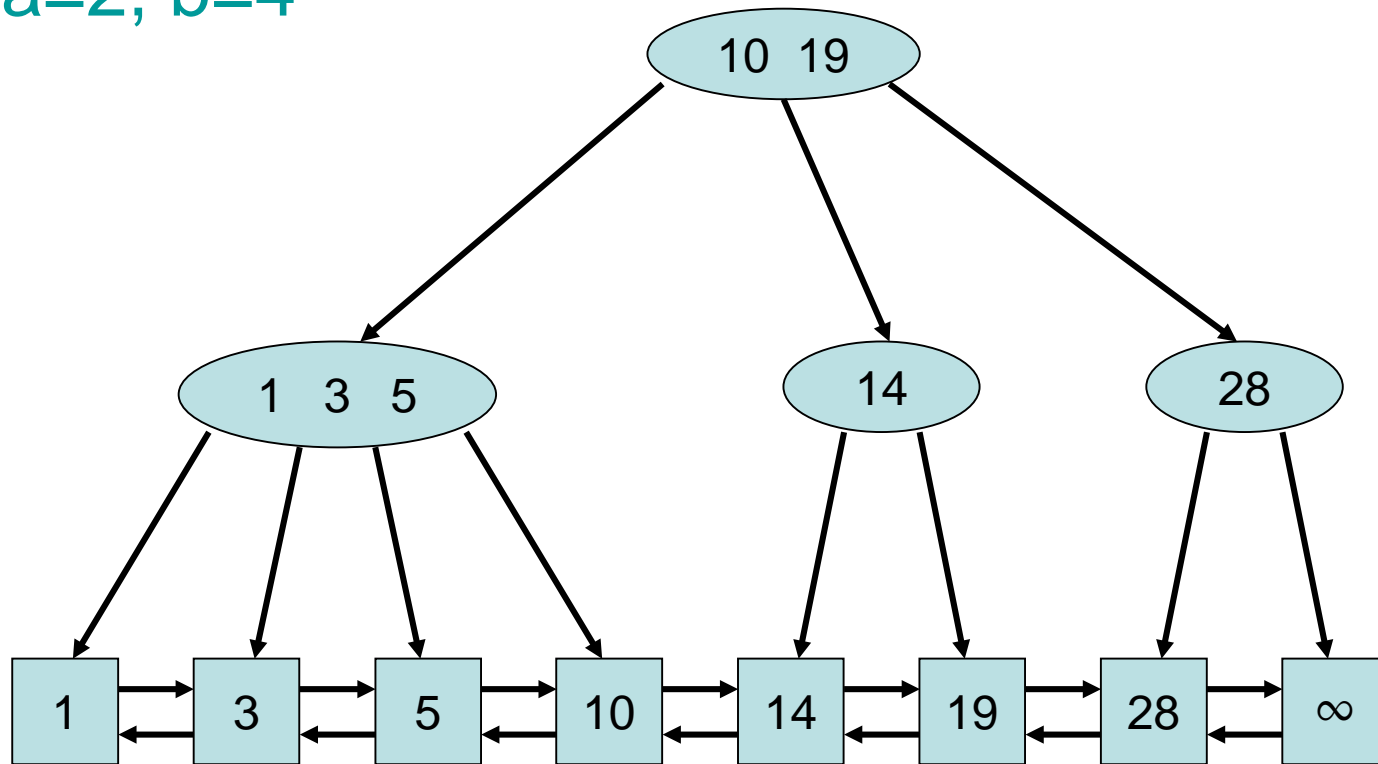

Insert(8)

a=2, b=4

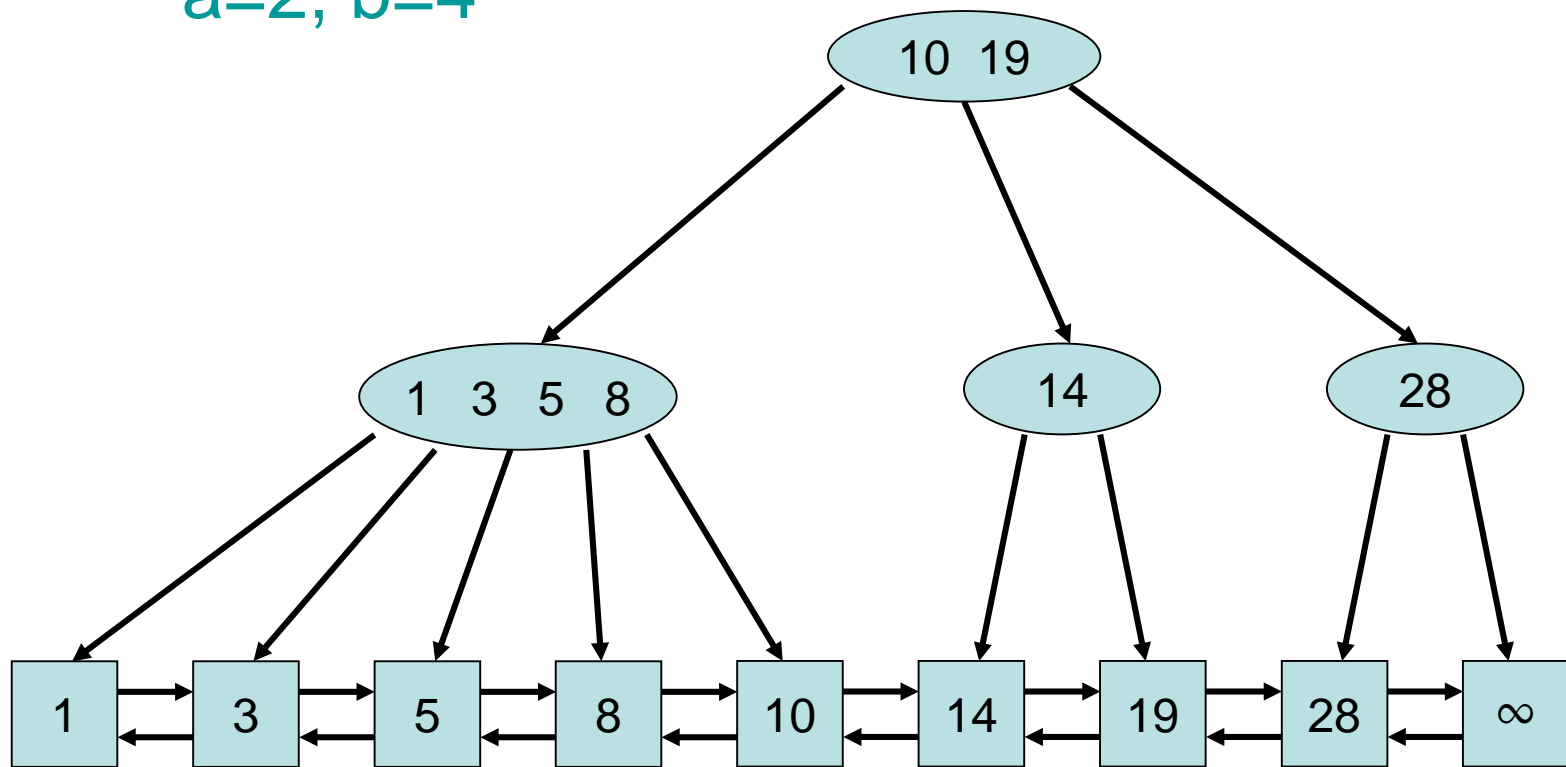

Insert(8)

a=2, b=4

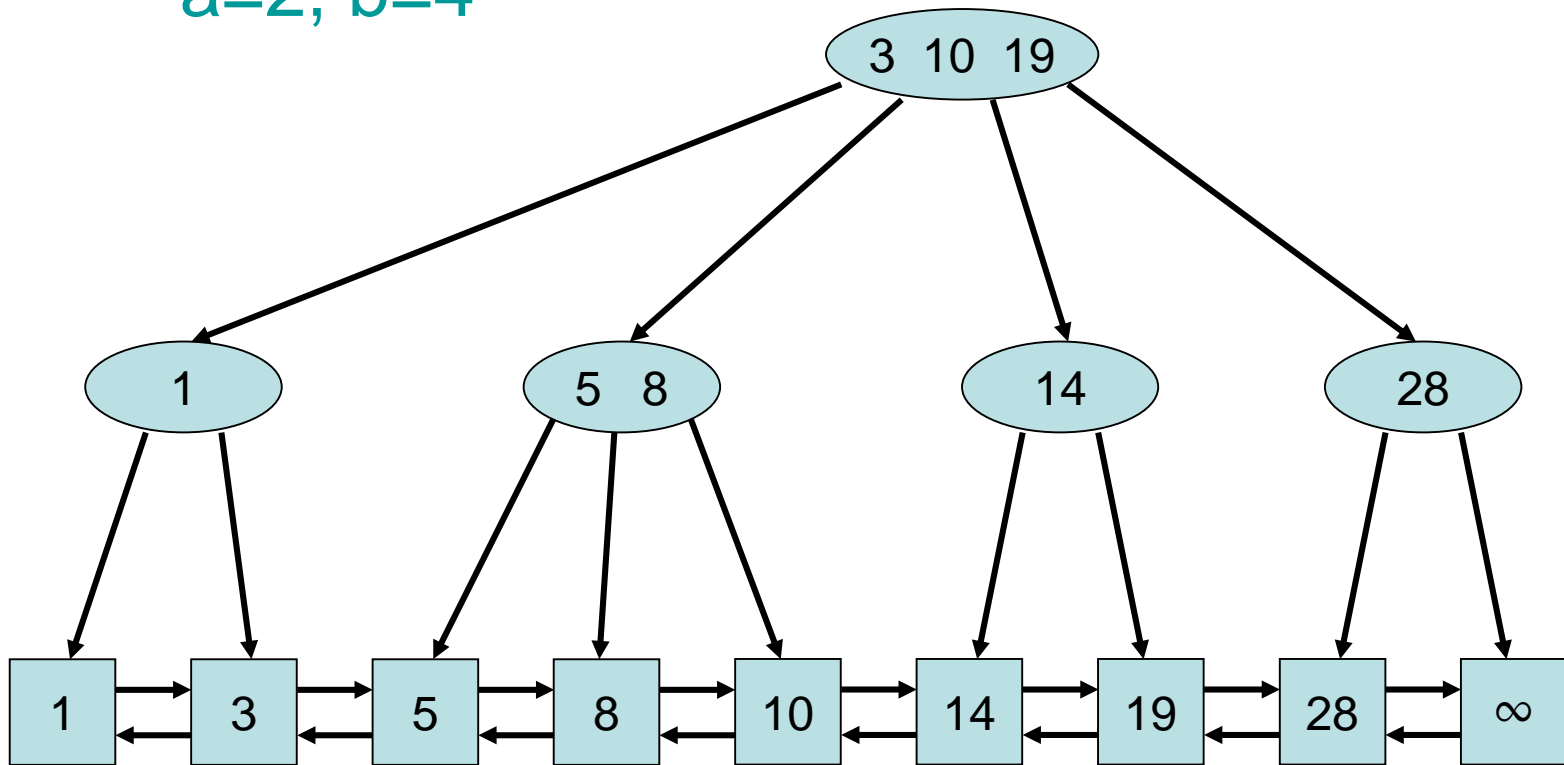

Insert(6)

a=2, b=4

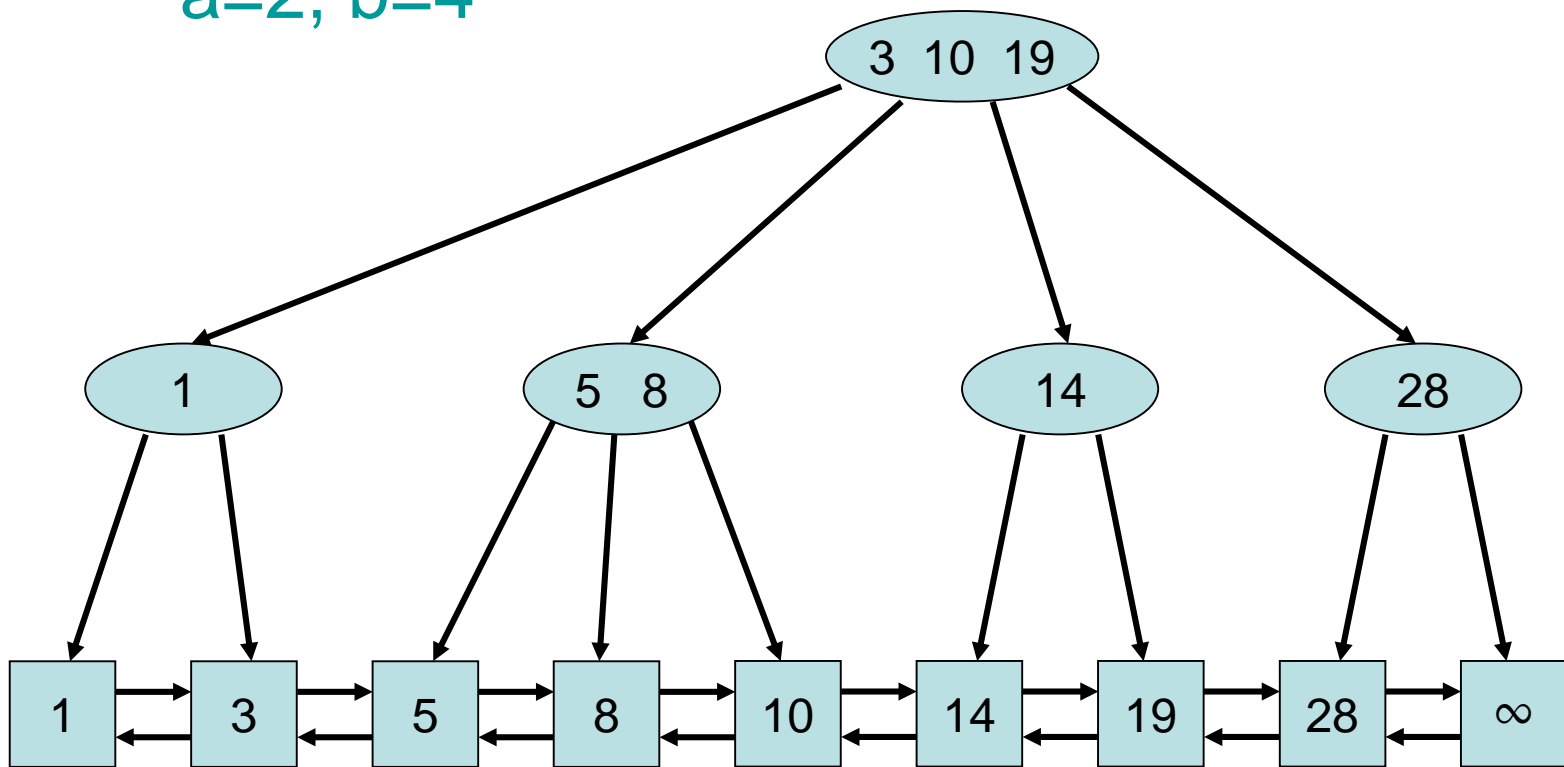

Insert(6)

a=2, b=4

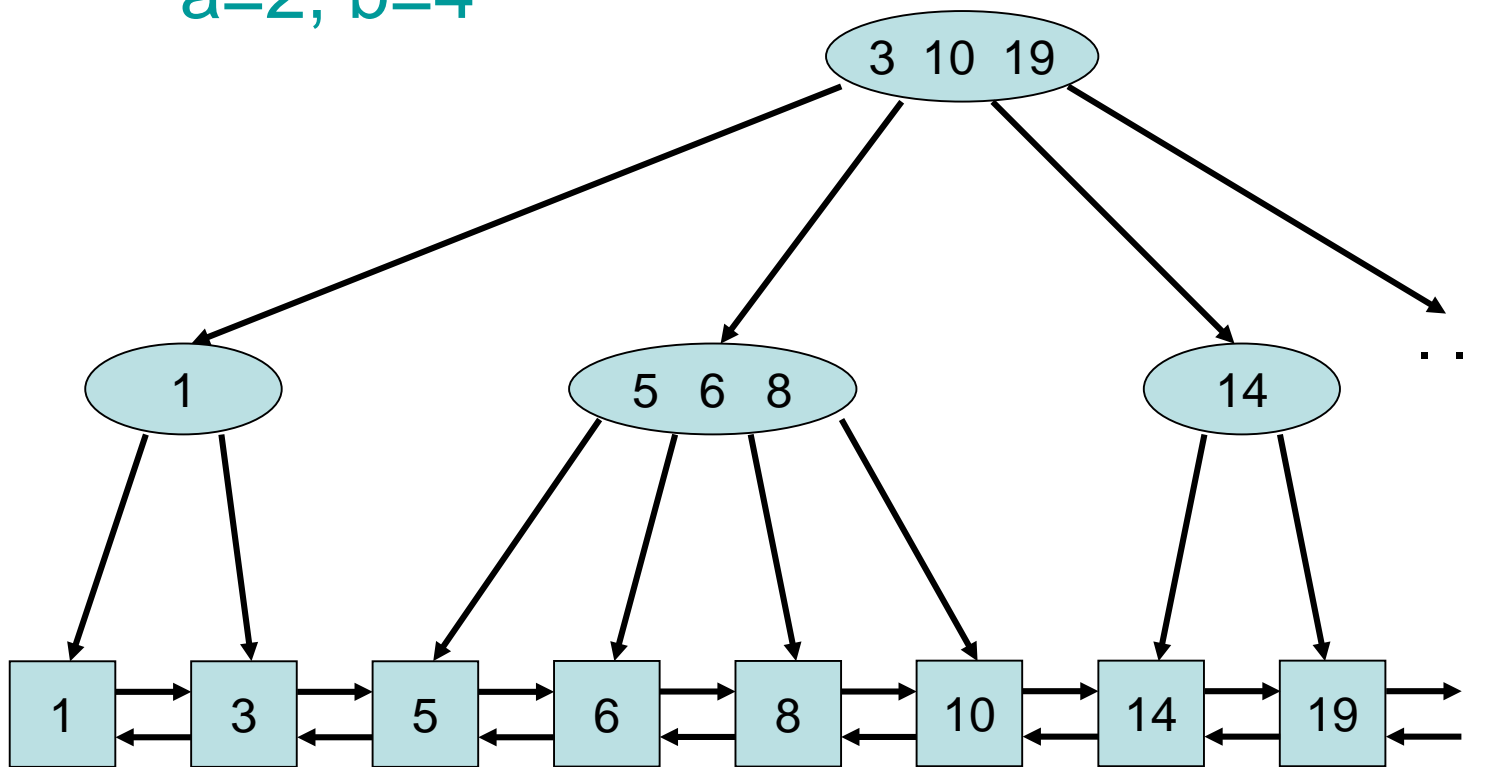

Insert(7)

a=2, b=4

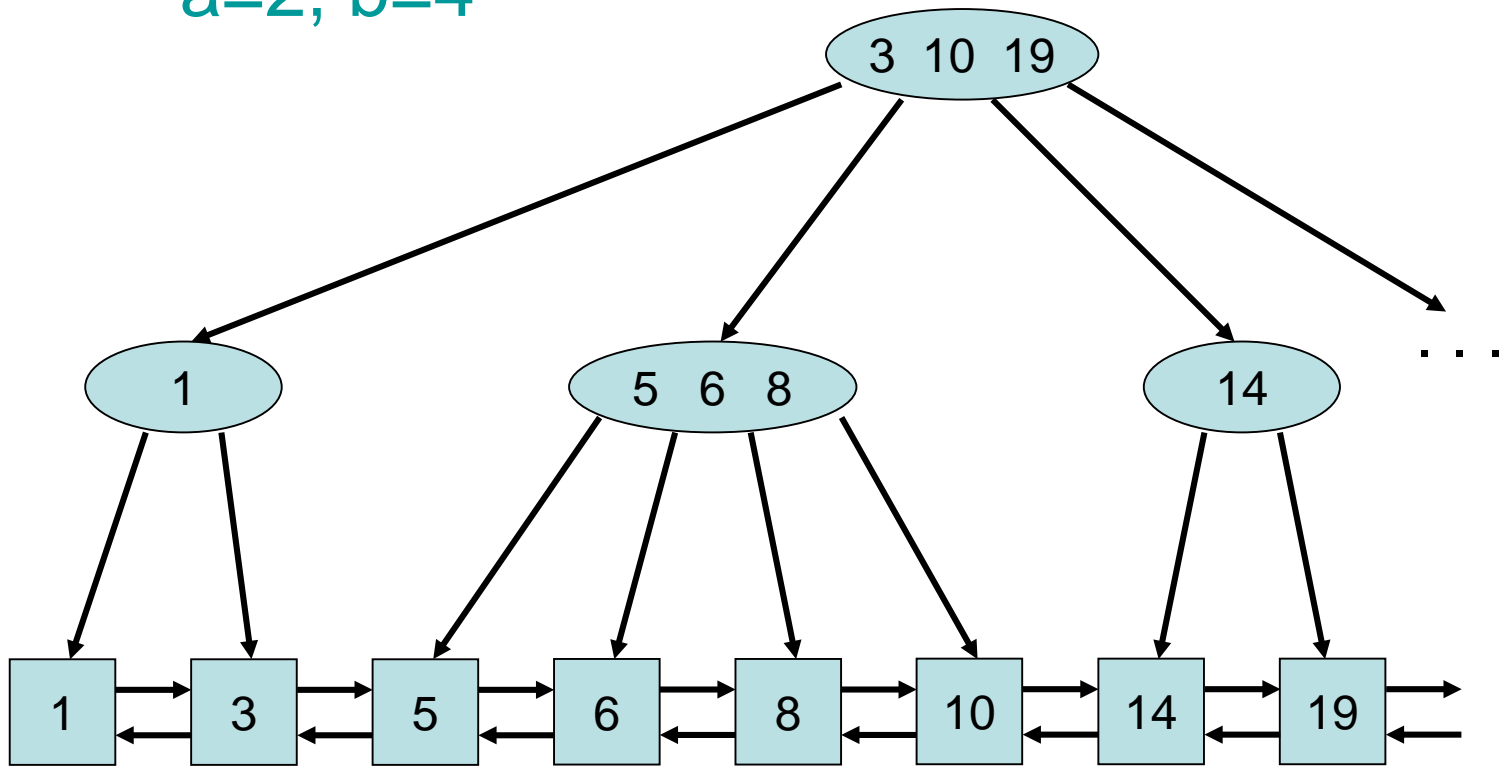

Insert(7)

a=2, b=4

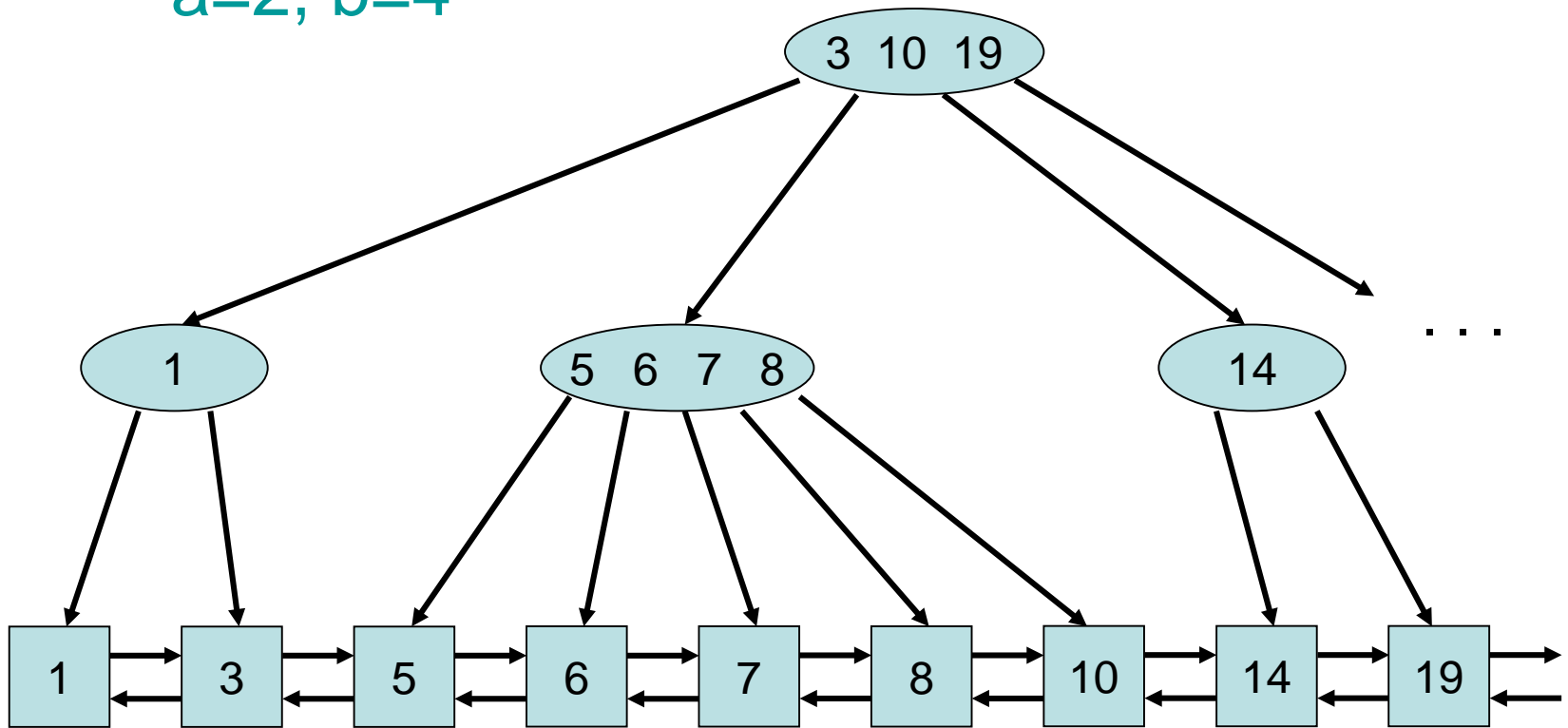

Insert(7)

a=2, b=4

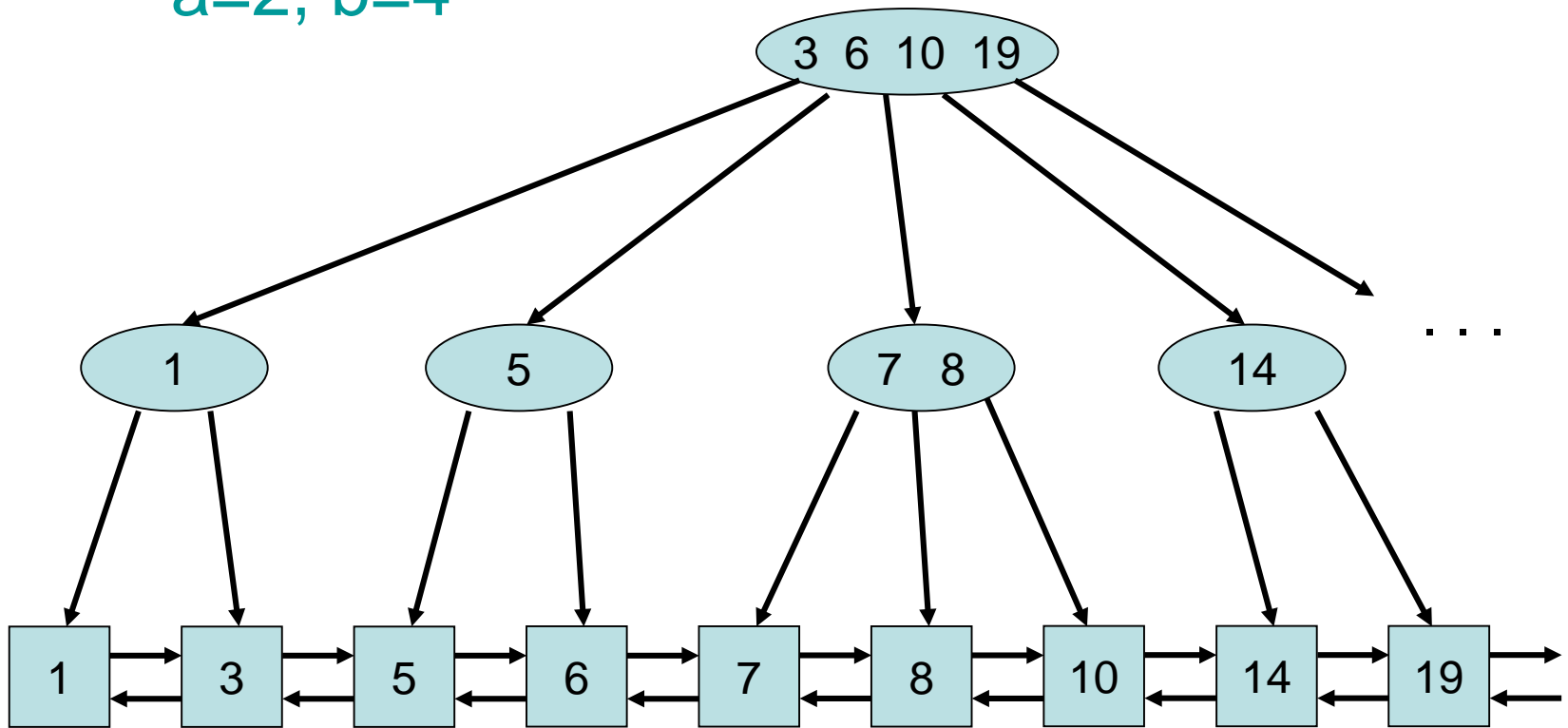

Insert(7)

a=2, b=4

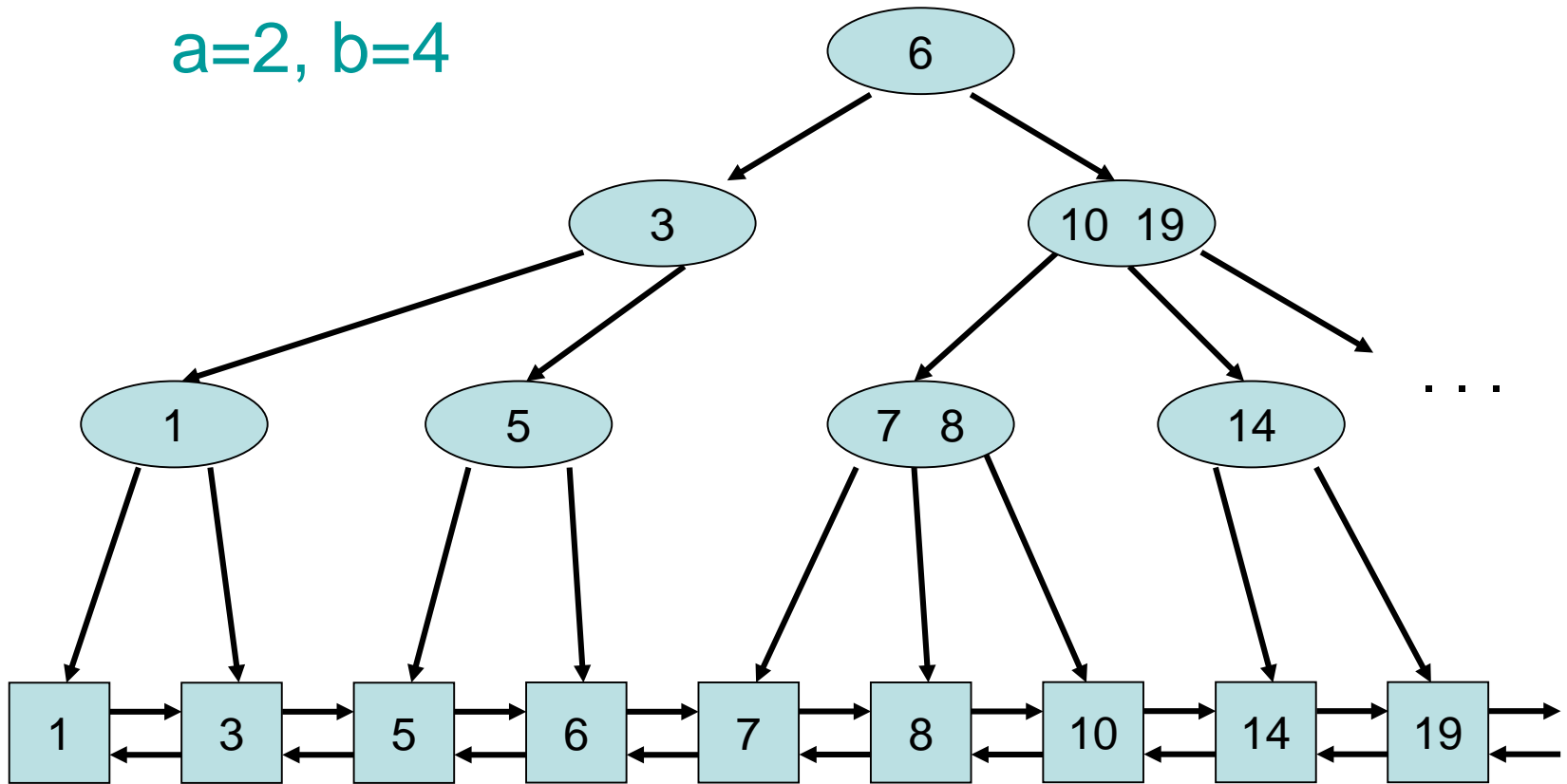

Insert Operation

- **Form Invariant:**

For all leaves v, w : $t(v)=t(w)$
Satisfied by Insert!

- **Degree Invariant:**

For all inner nodes v except for the root:
 $d(v) \in [a, b]$, for root r : $d(r) \in [2, b]$

1) Insert splits nodes of degree $b+1$ into nodes of degree $\lfloor (b+1)/2 \rfloor$ and $\lceil (b+1)/2 \rceil$. If $b \geq 2a-1$, then both values are at least a .

2) If root has reached degree $b+1$, then a new root of degree 2 is created.

Delete(k) Operation

Strategy:

- First $\text{search}(k)$ until some element e is reached in the list. If $\text{key}(e)=k$, remove e from the list, otherwise we are done.

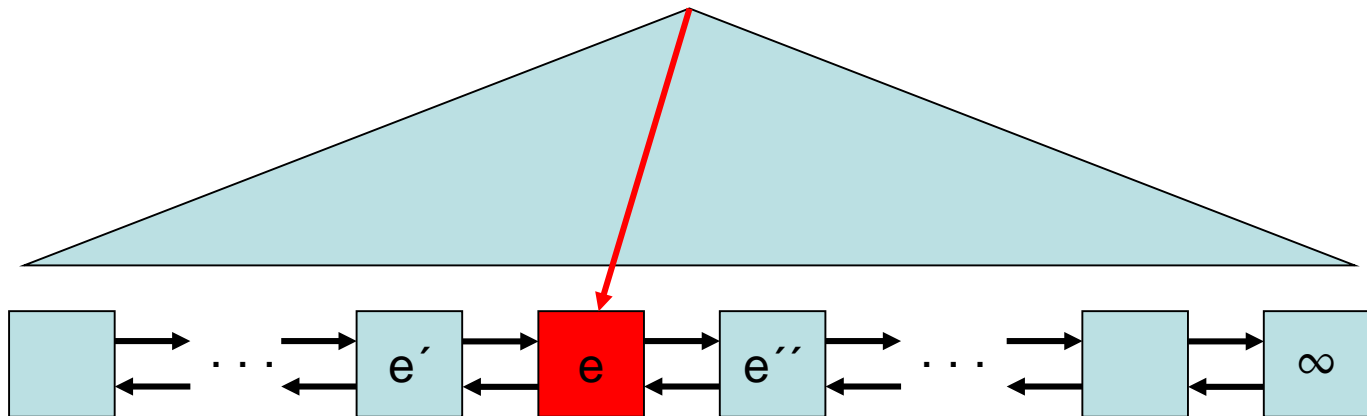

Delete(k) Operation

Strategy:

- First $\text{search}(k)$ until some element e is reached in the list. If $\text{key}(e)=k$, remove e from the list, otherwise we are done.

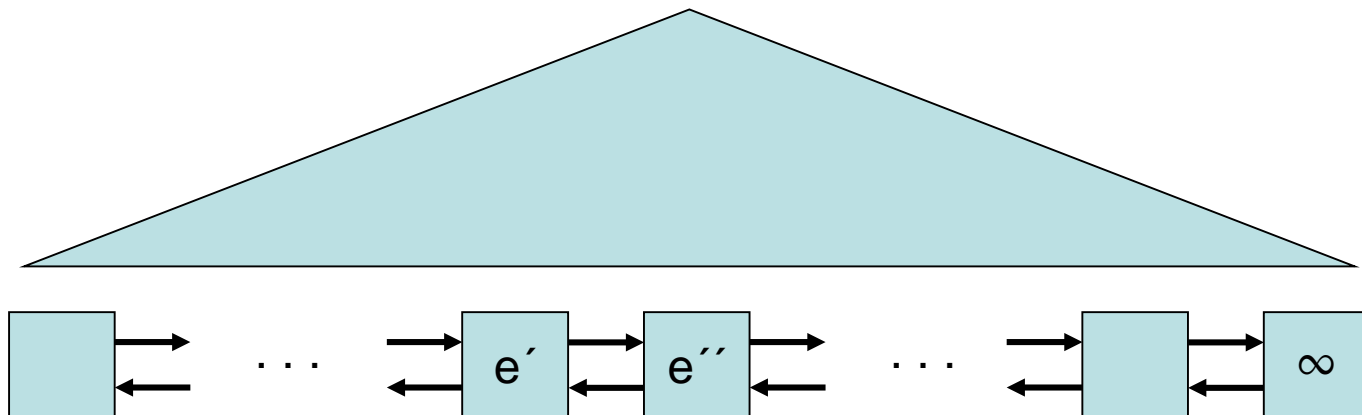

Delete(k) Operation

- Remove pointer to e and key k from the leaf node v above e . (e rightmost child: perform **key exchange** like in binary tree!) If afterwards we still have $d(v) \geq a$, we are done.

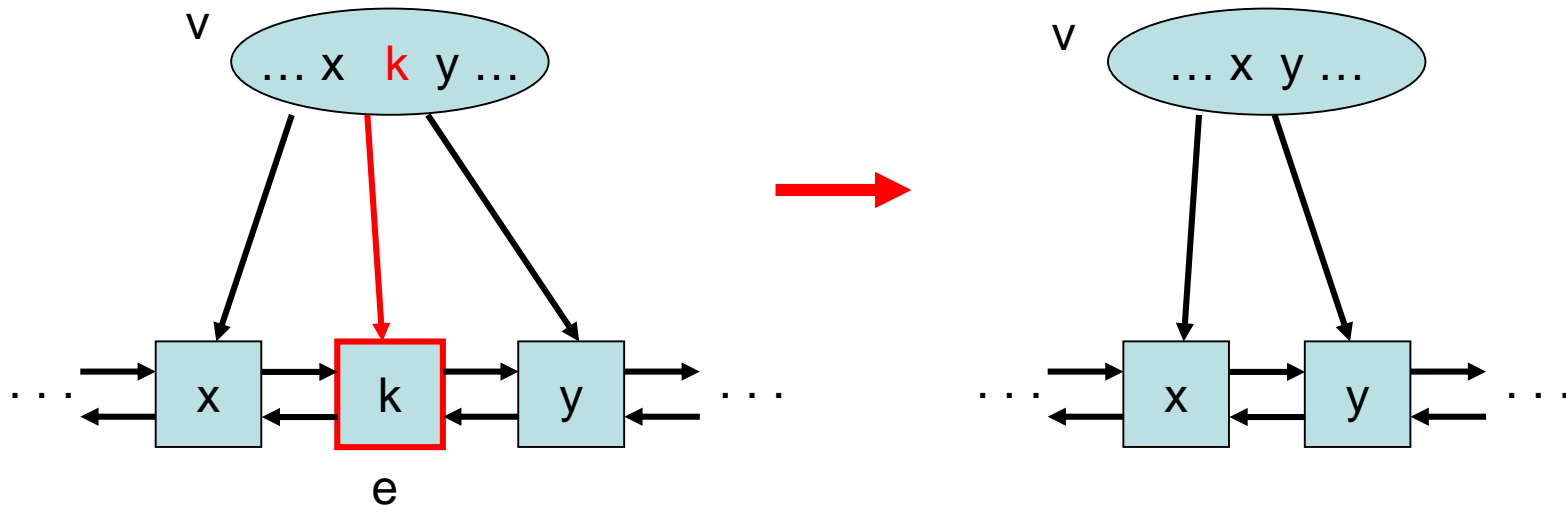

Delete(k) Operation

- Remove pointer to e and key k from the leaf node v above e . (e rightmost child: perform **key exchange** like in binary tree!) If afterwards we still have $d(v) \geq a$, we are done.

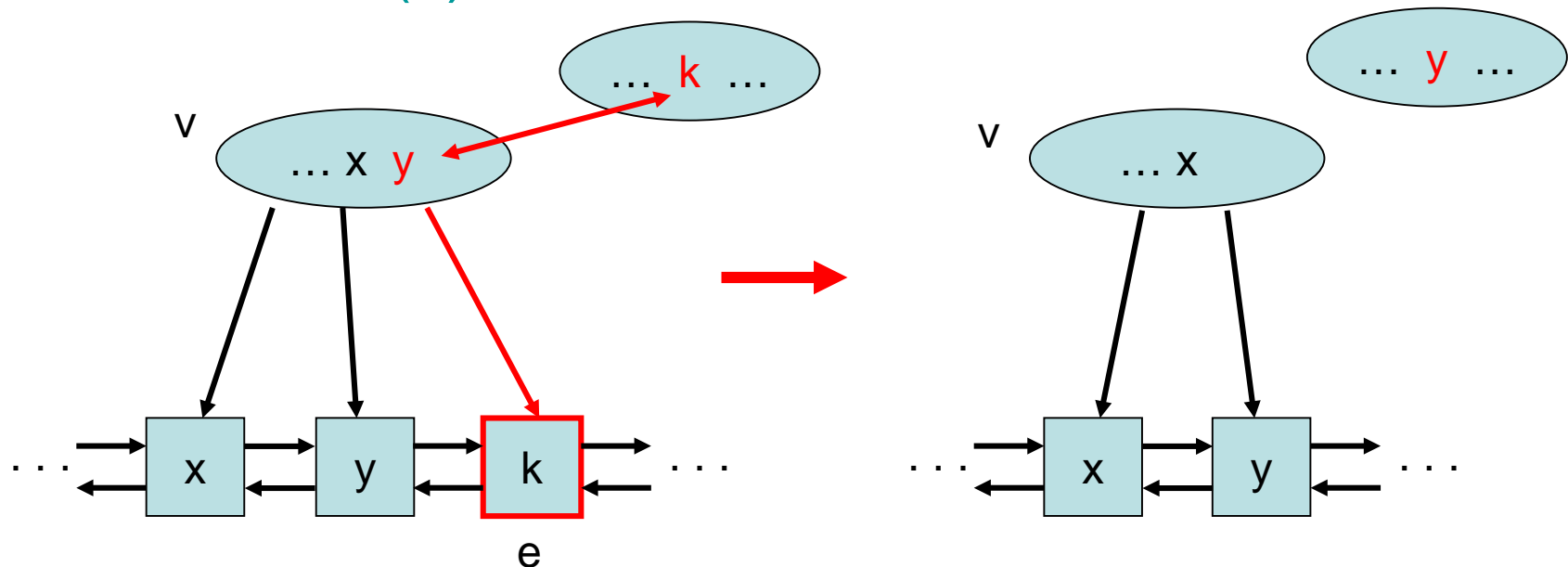

Delete(k) Operation

- If $d(v) < a$ and the preceding or succeeding sibling of v has degree $> a$, steal an edge from that sibling. (Example: $a=2$, $b=4$)

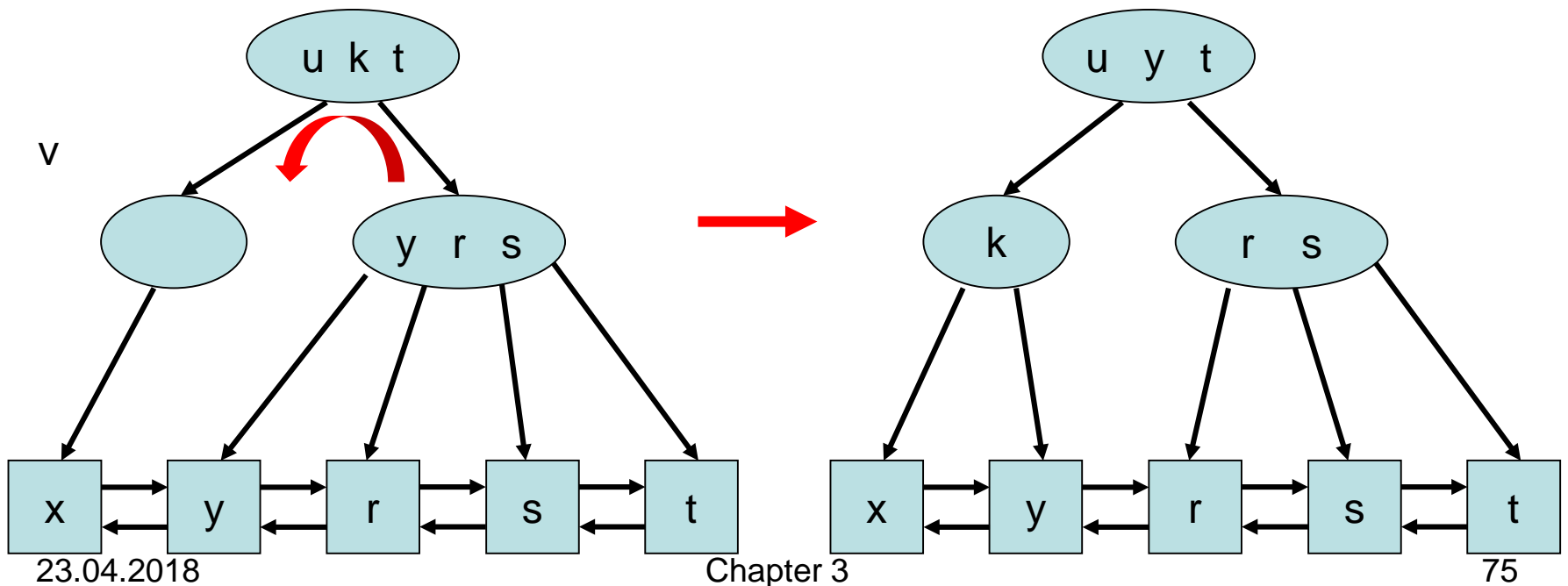

Delete(k) Operation

- If $d(v) < a$ and the preceding and succeeding siblings of v have degree a , merge v with one of these. (Example: $a=3$, $b=5$)

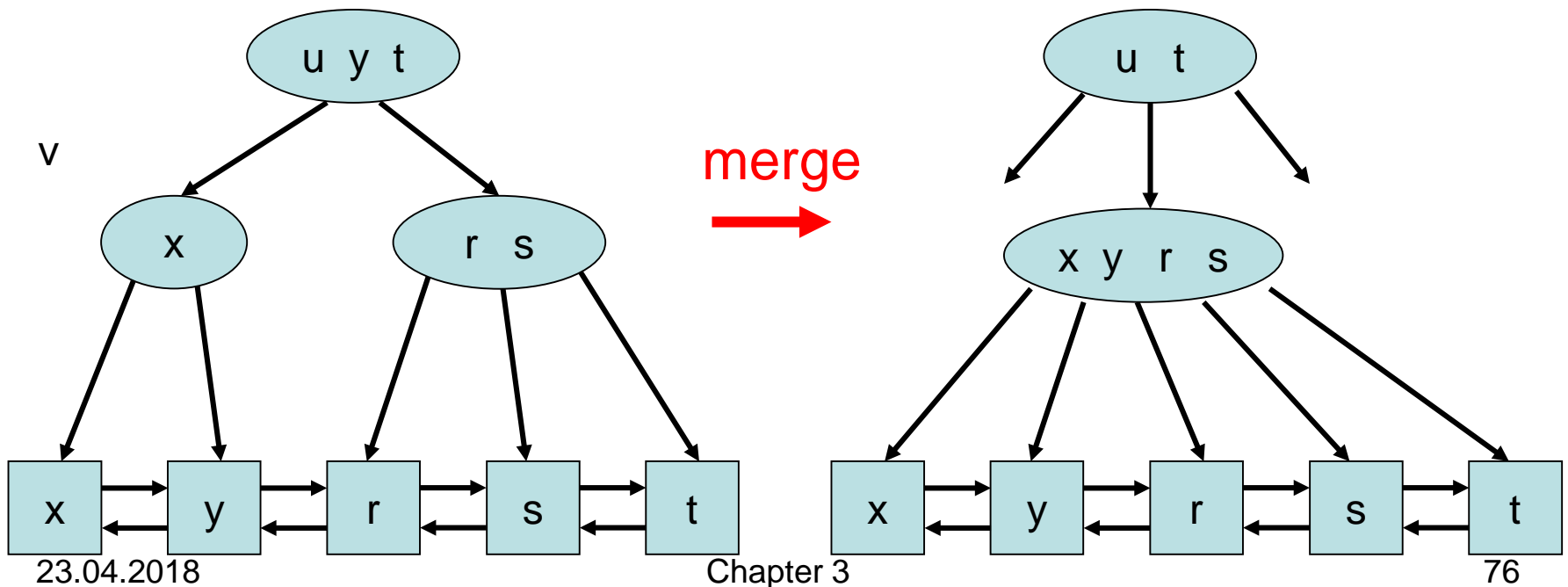

Delete(k) Operation

- Perform changes upwards until all inner nodes (except for the root) have degree $\geq a$. If root has degree < 2 : remove root.

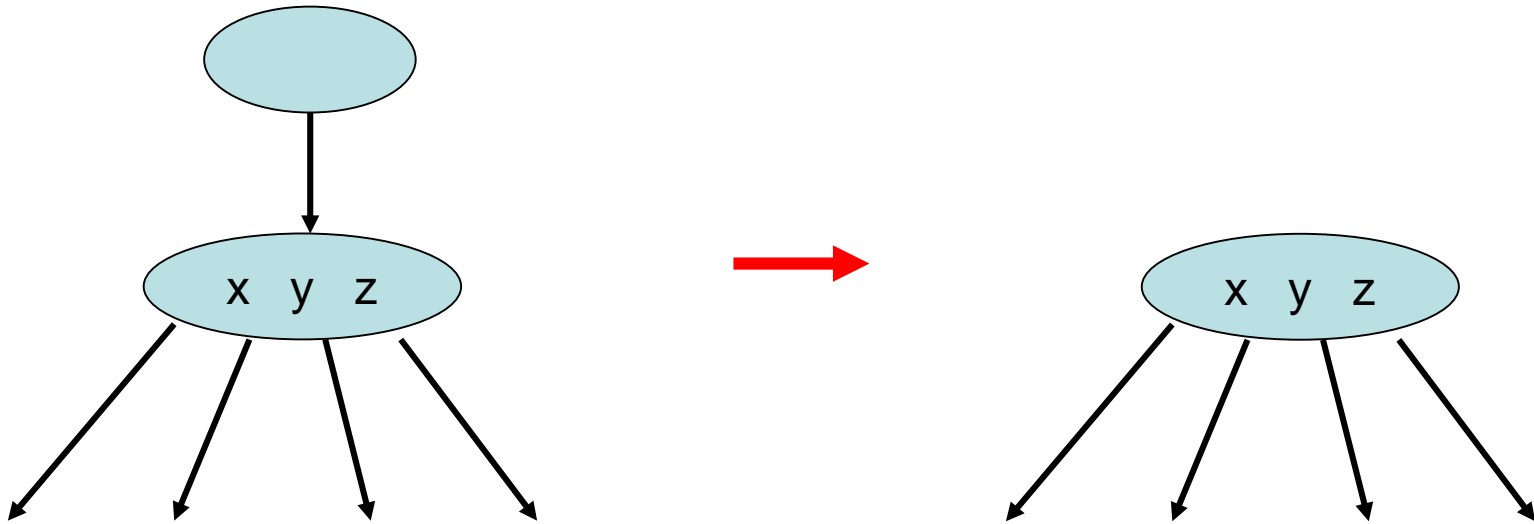

Delete(10)

a=2, b=4

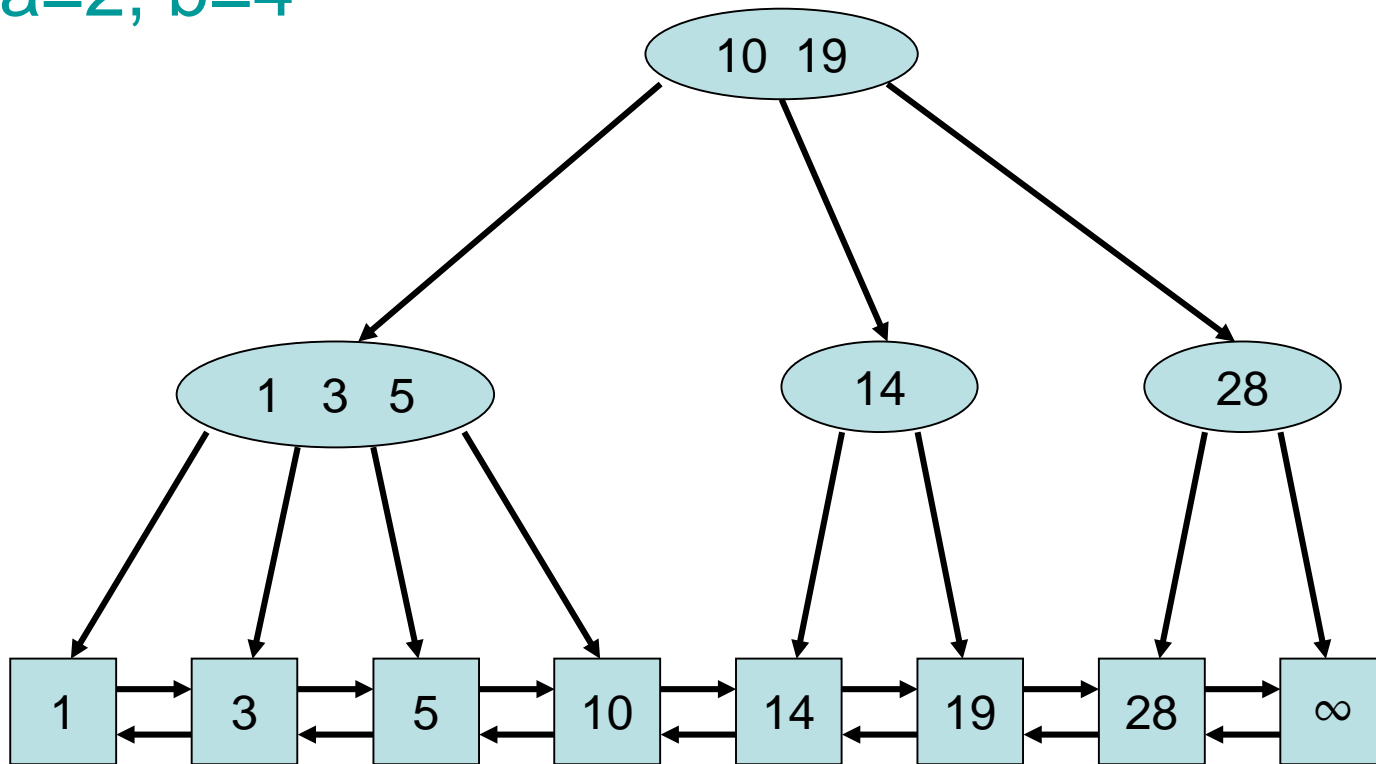

Delete(10)

a=2, b=4

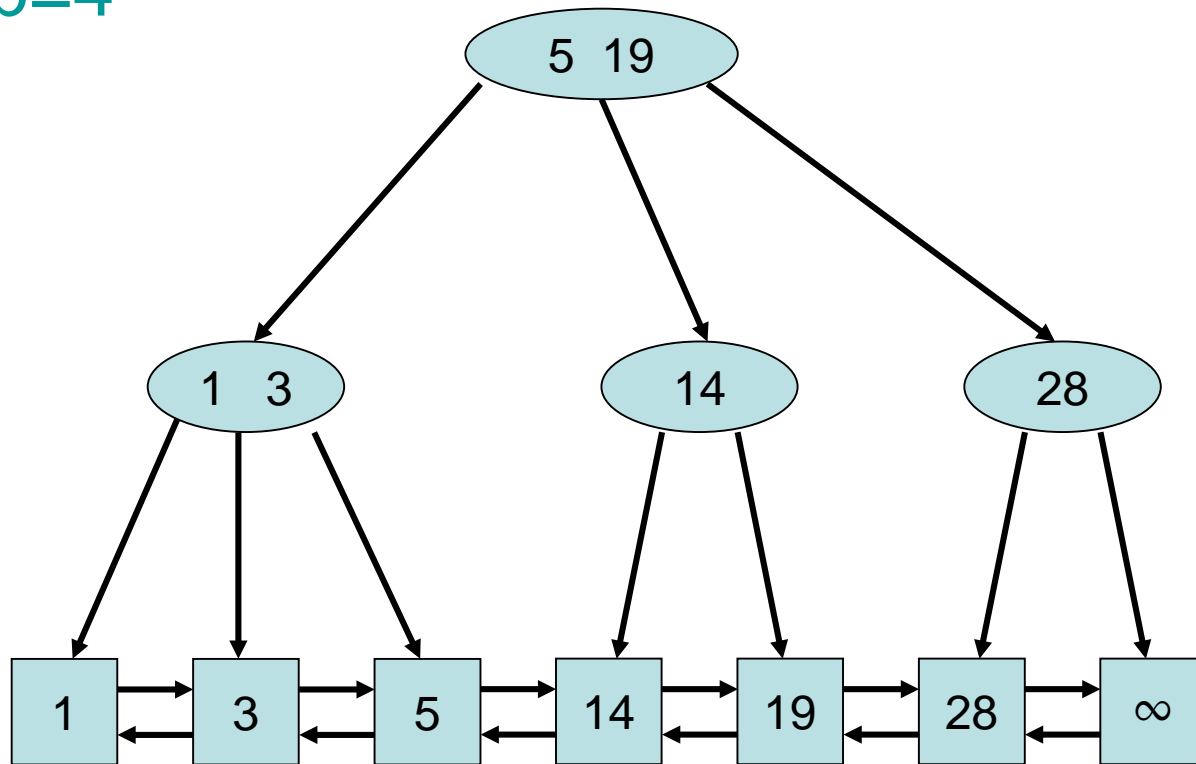

Delete(14)

a=2, b=4

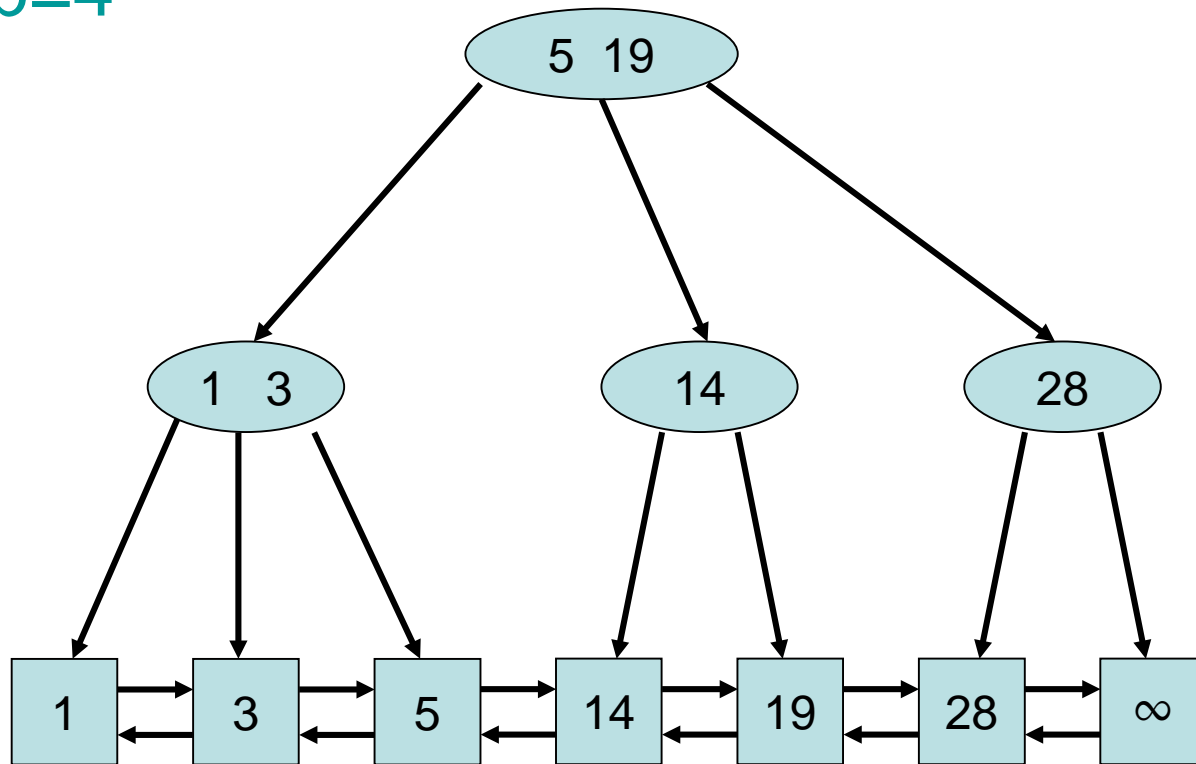

Delete(14)

a=2, b=4

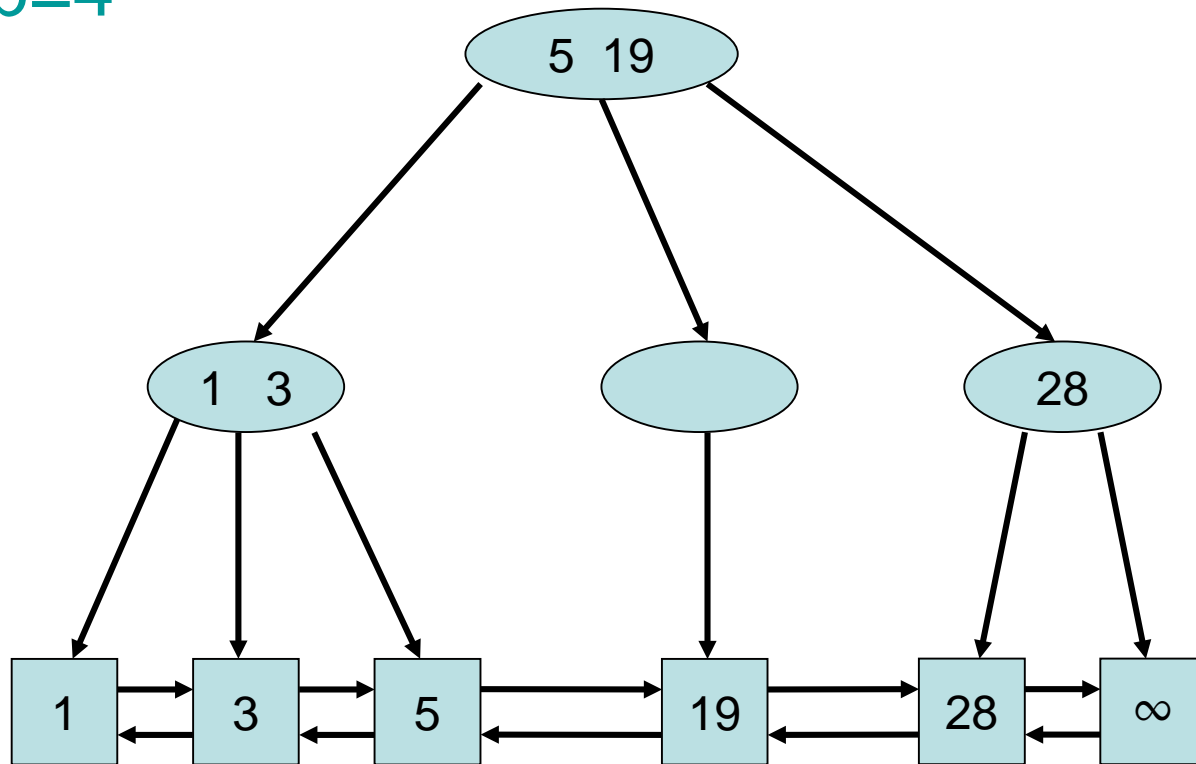

Delete(14)

a=2, b=4

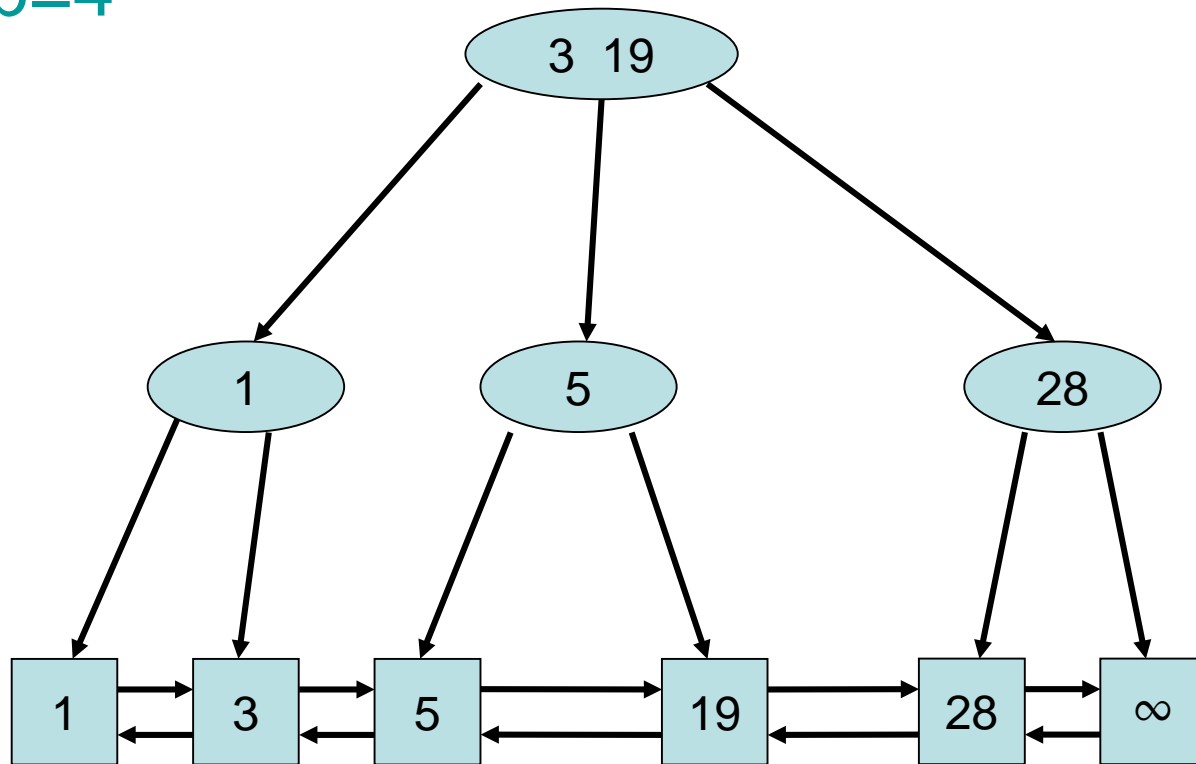

Delete(3)

a=2, b=4

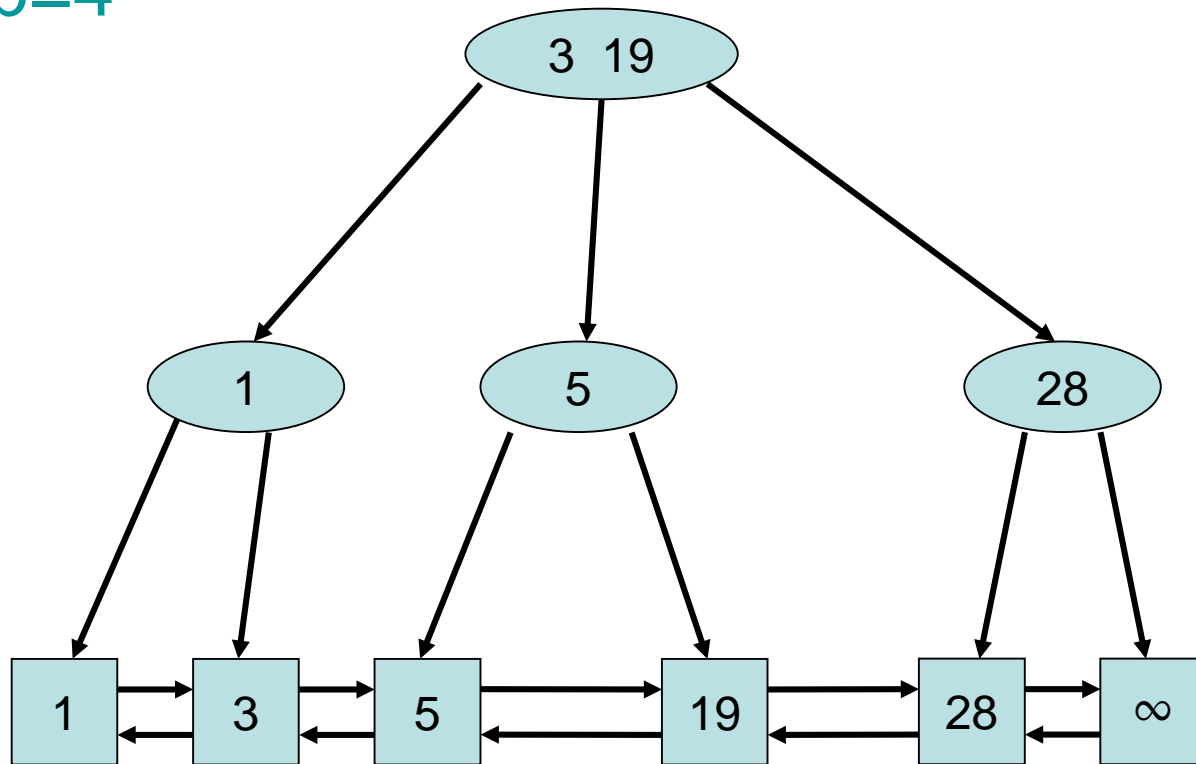

Delete(3)

a=2, b=4

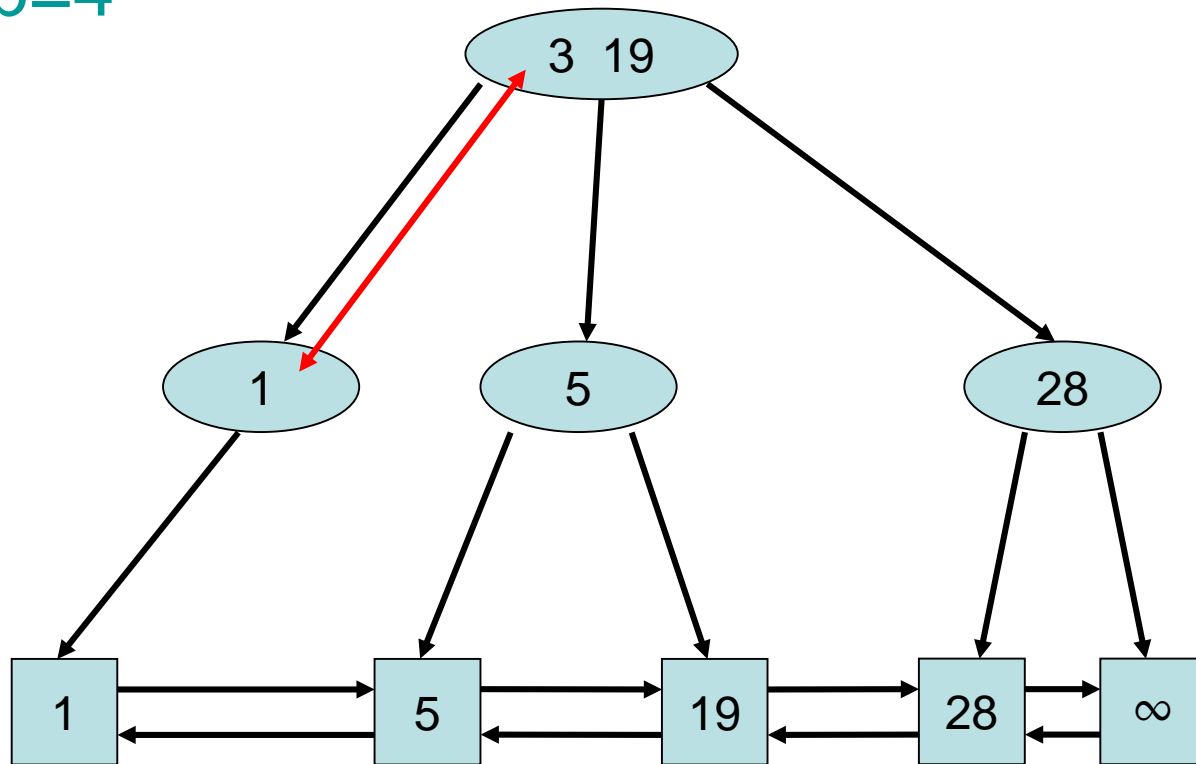

Delete(3)

a=2, b=4

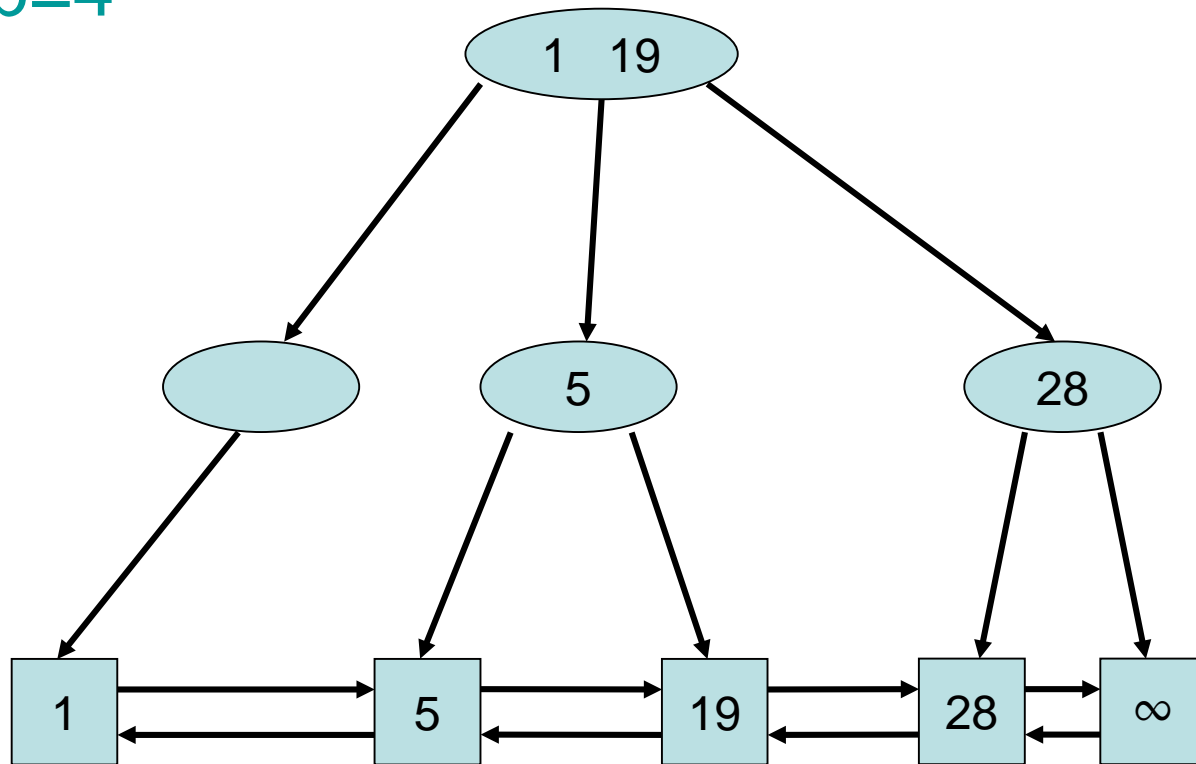

Delete(3)

a=2, b=4

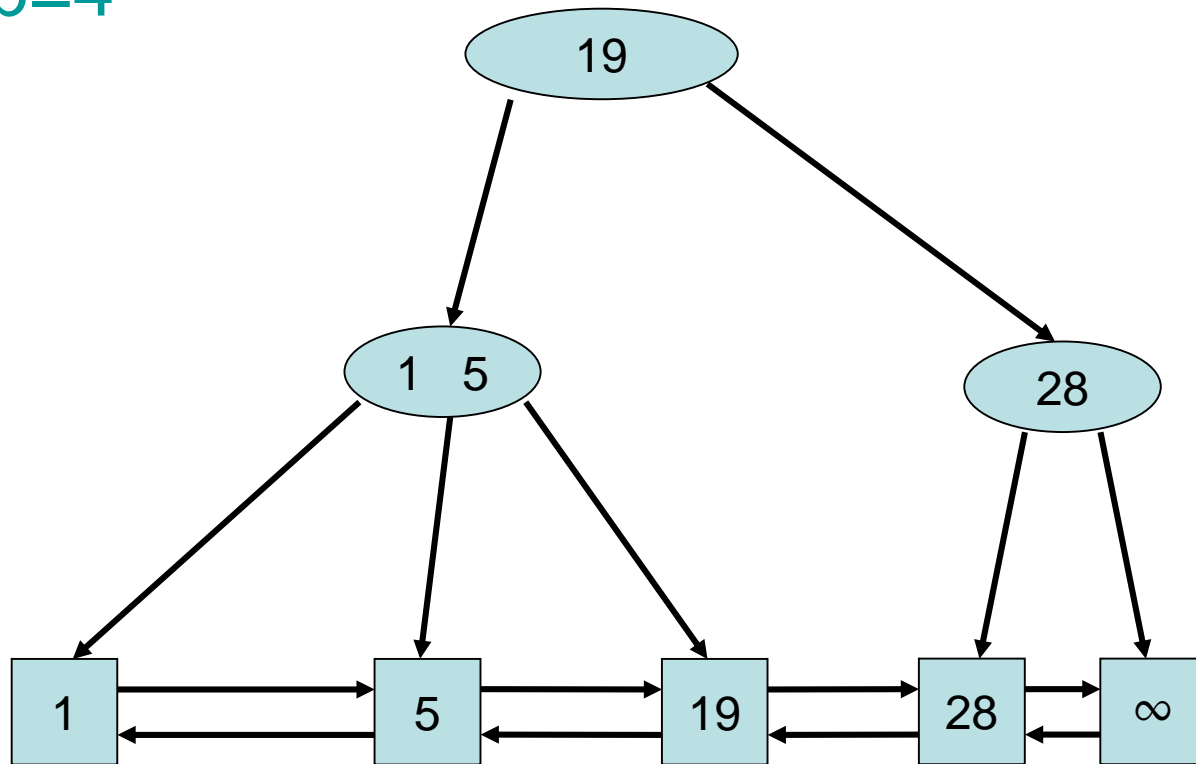

Delete(1)

a=2, b=4

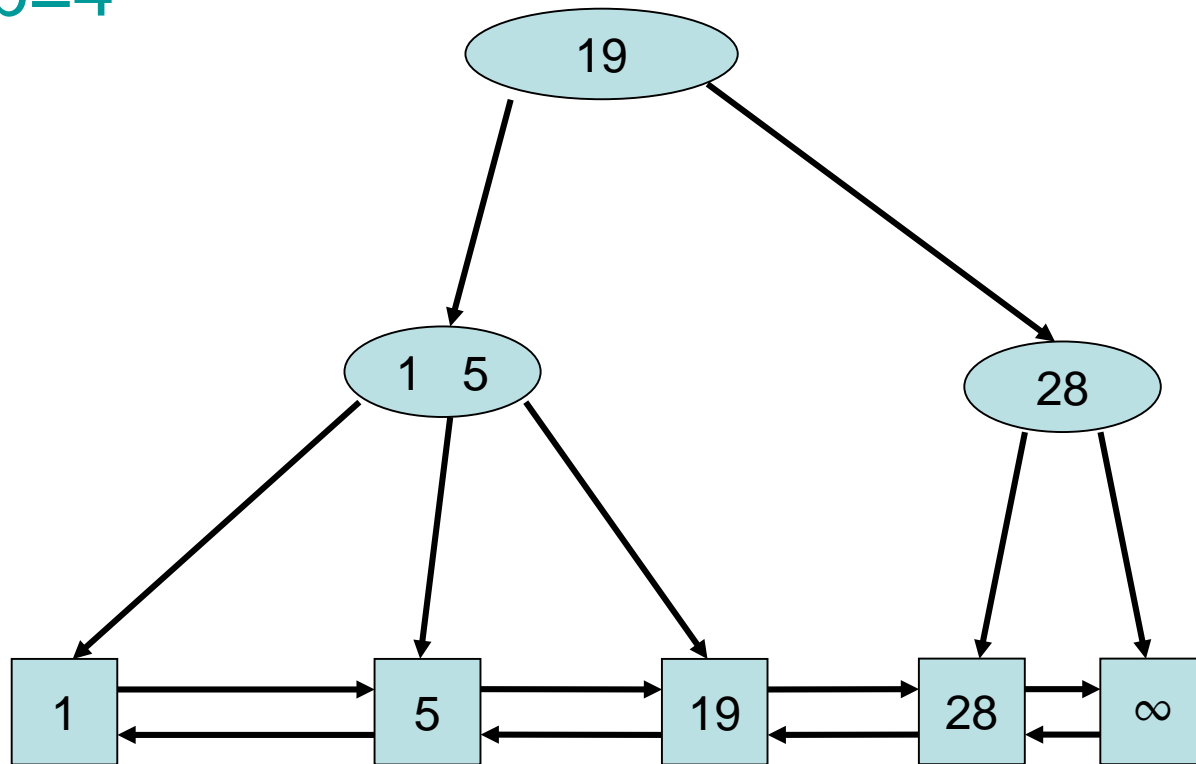

Delete(1)

a=2, b=4

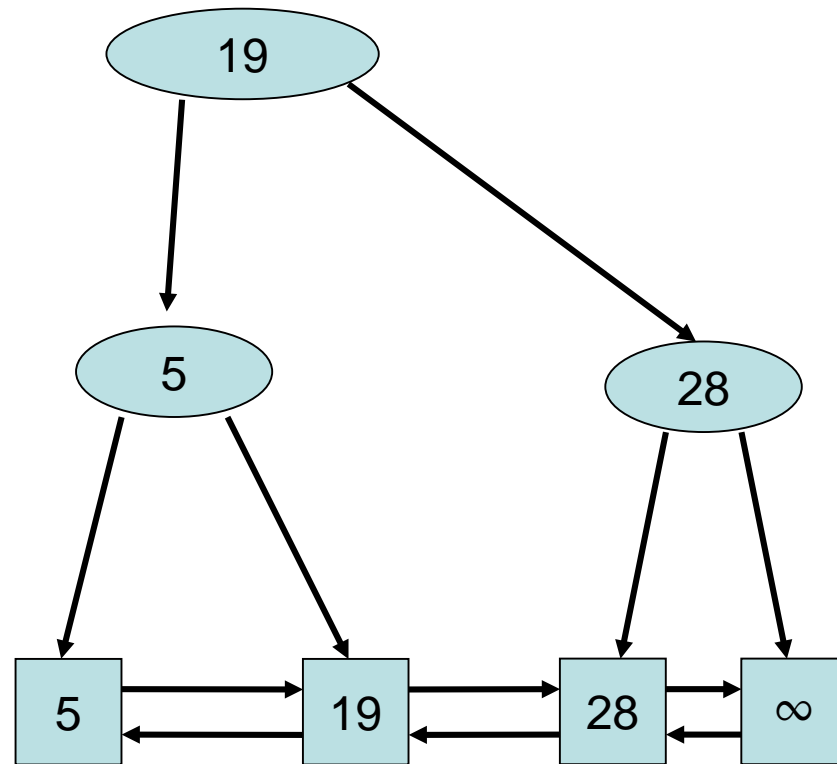

Delete(19)

a=2, b=4

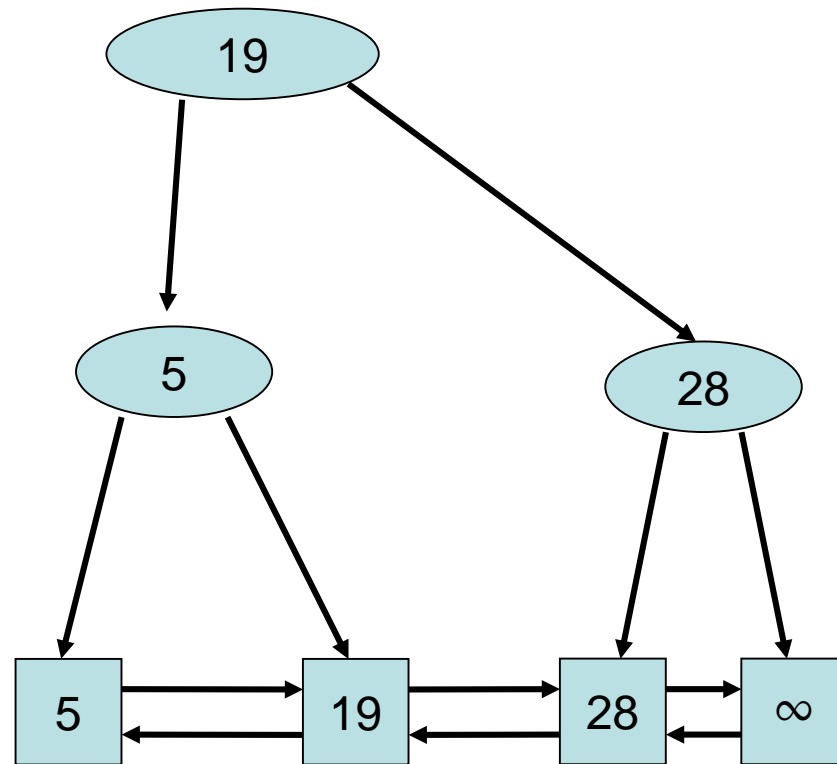

Delete(19)

a=2, b=4

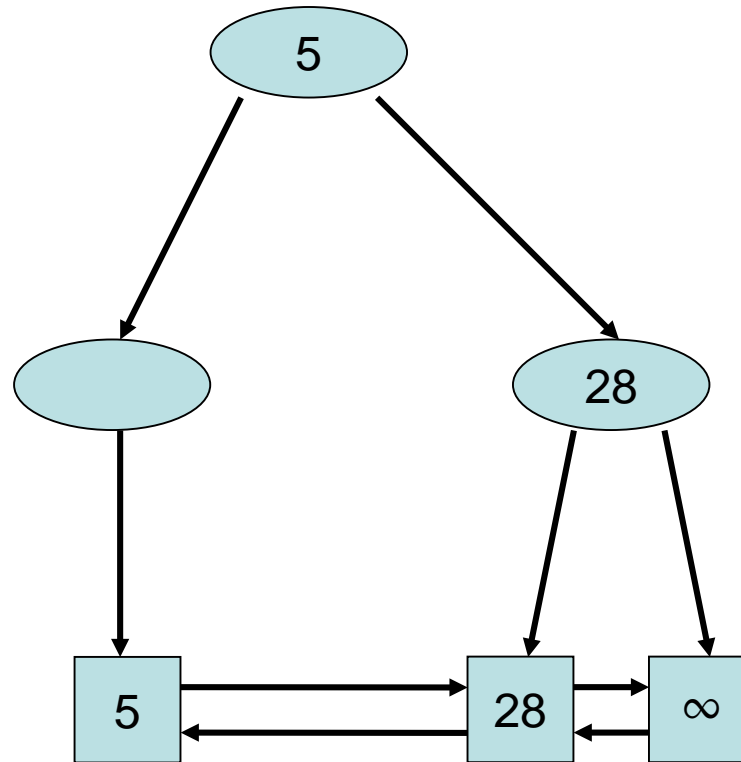

Delete(19)

a=2, b=4

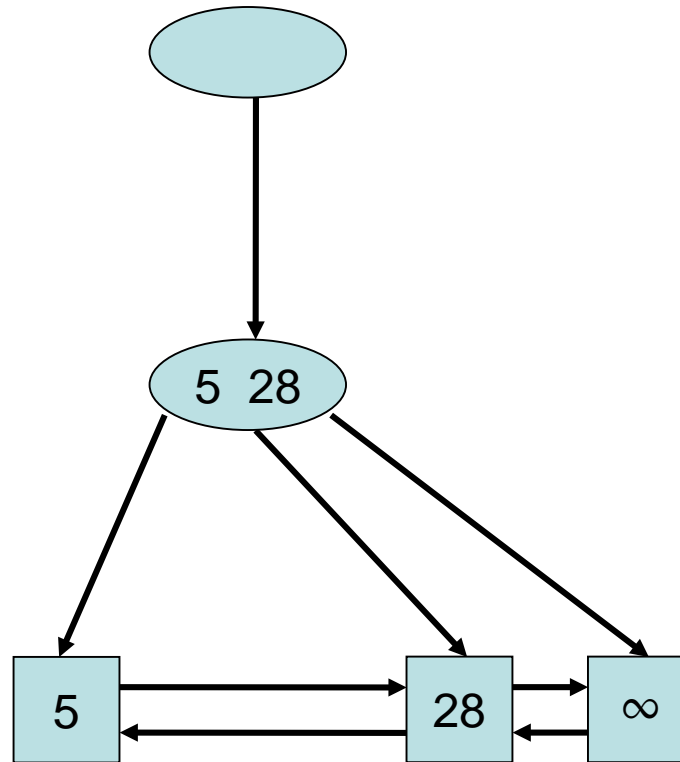

Delete(19)

a=2, b=4

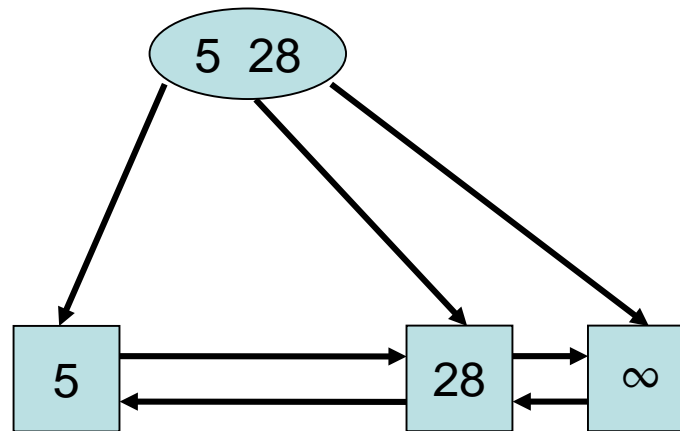

Delete Operation

- **Form Invariant:**
For all leaves v, w : $t(v)=t(w)$
Satisfied by Delete!
- **Degree Invariant:**
For all inner nodes v except for the root: $d(v) \in [a, b]$, for root r : $d(r) \in [2, b]$
 - 1) **Delete** merges node of degree $a-1$ with node of degree a . Since $b \geq 2a-1$, the resulting node has degree at most b .
 - 2) **Delete** moves edge from a node of degree $>a$ to a node of degree $a-1$. Also OK.
 - 3) Root deleted: children have been merged, degree of the remaining child is $\geq a$ (and also $\leq b$), so also OK.

Application: External (a,b)-Tree

(a,b)-trees well suited for large amounts of data

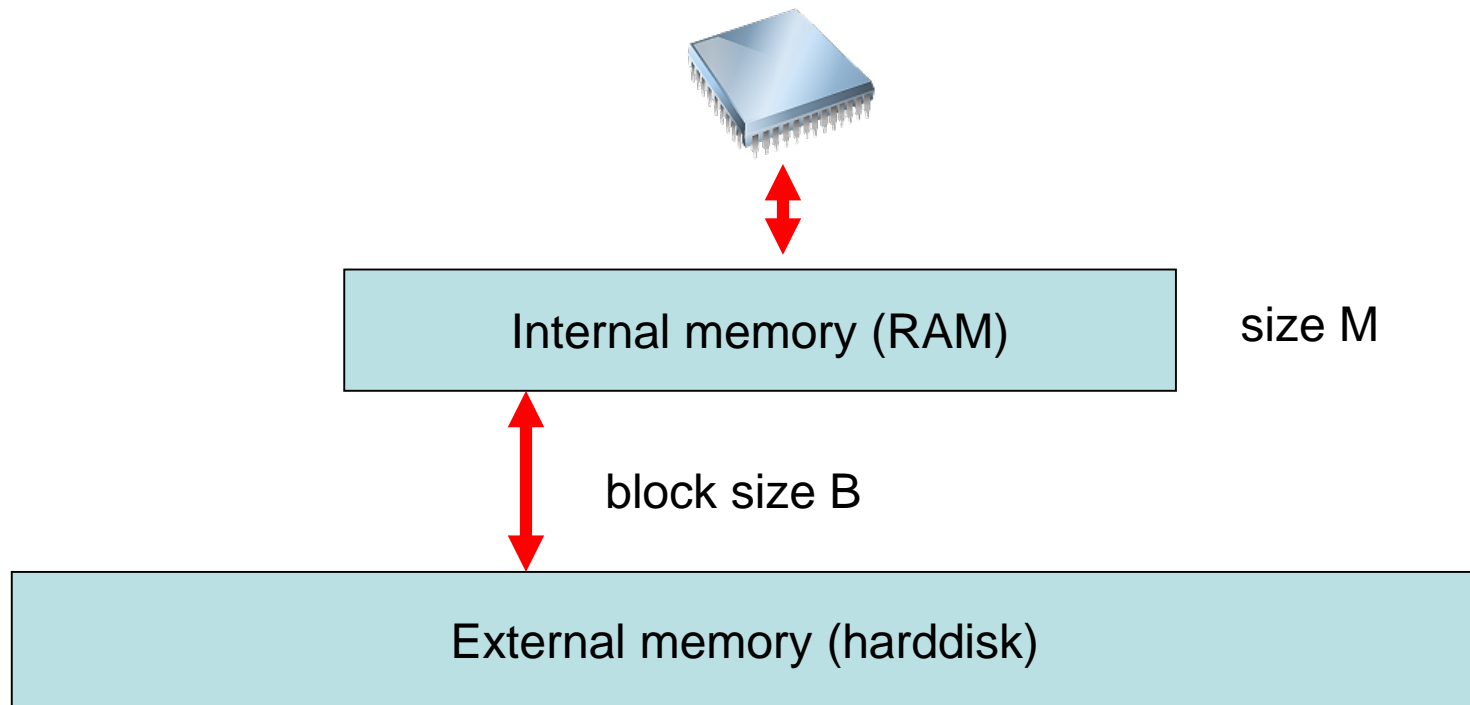

Overview

- Basic data structures
- Search structures (successor searching)
- Dictionaries (exact searching)

Dictionary

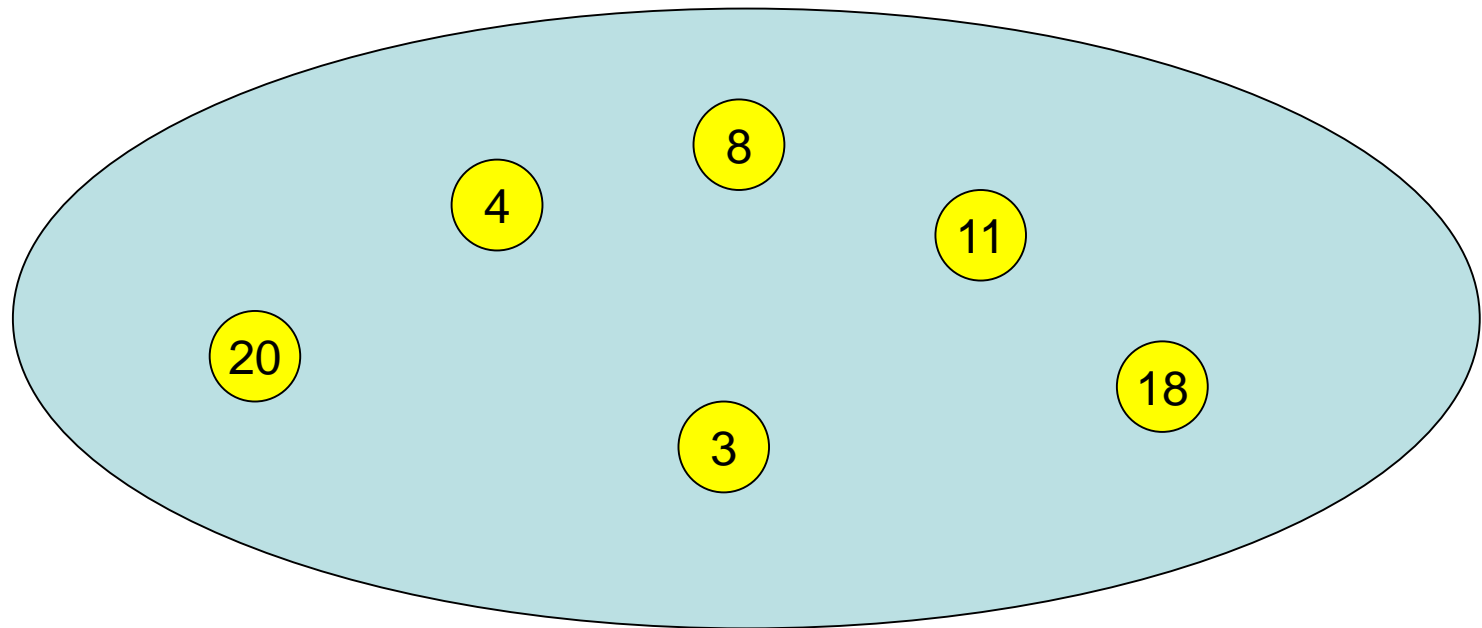

Dictionary

insert(15)

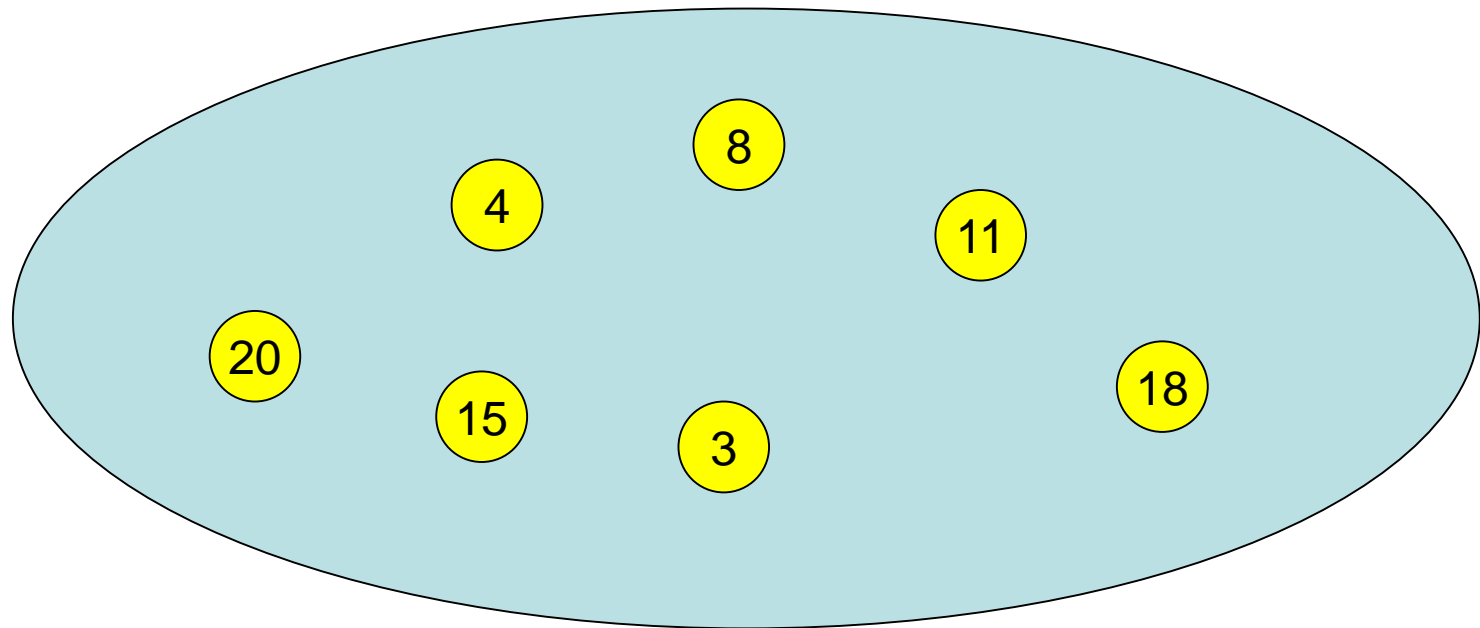

Dictionary

`delete(20)`

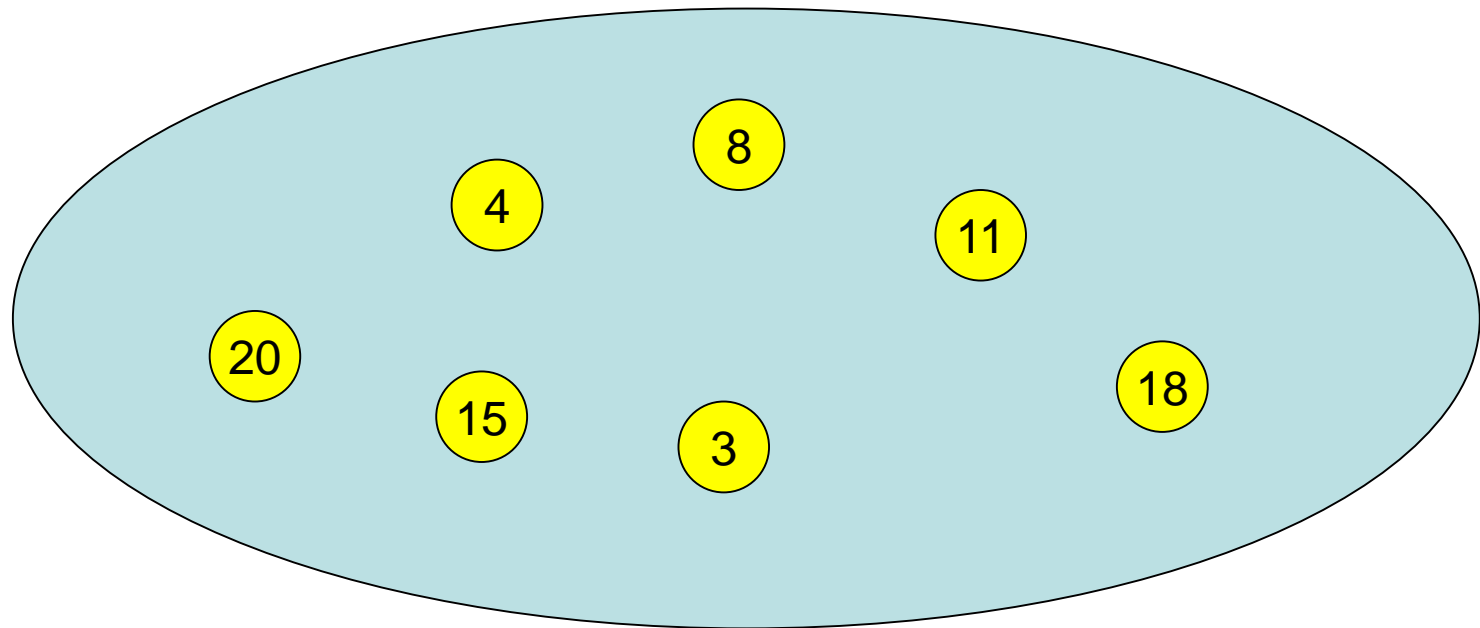

Dictionary

lookup(8) outputs 8

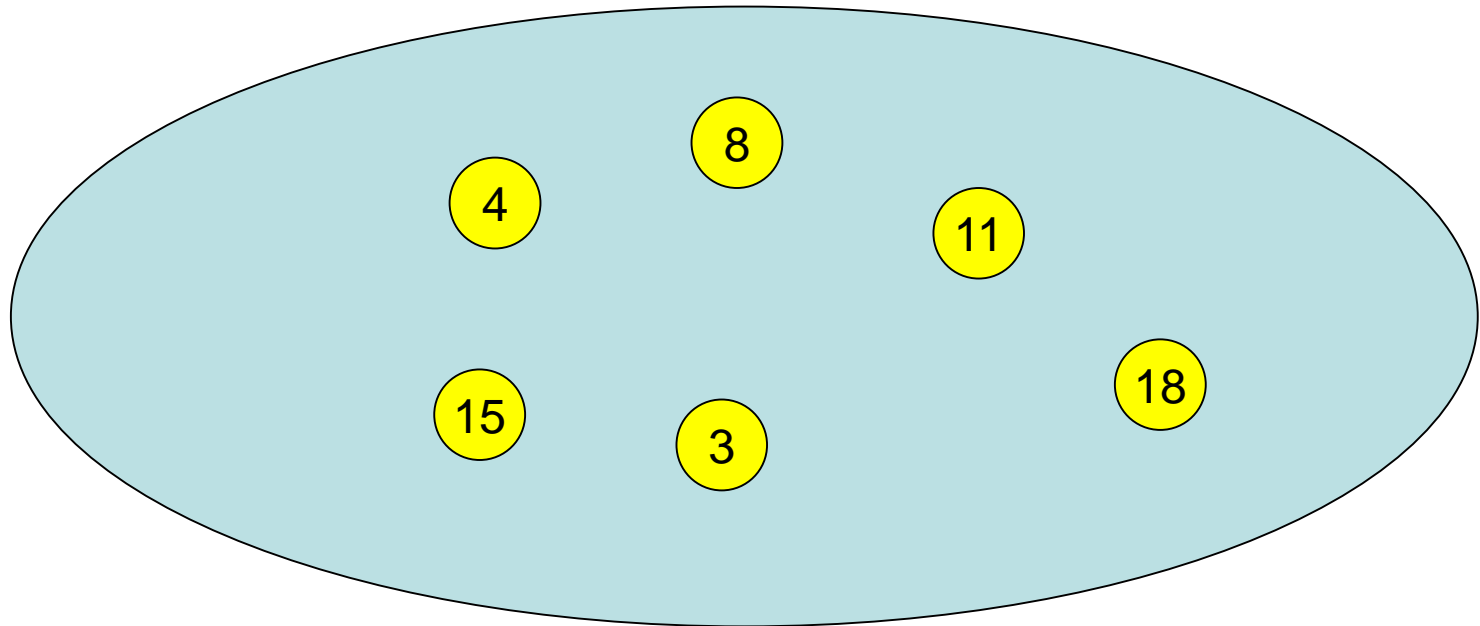

Dictionary

lookup(7) outputs \perp

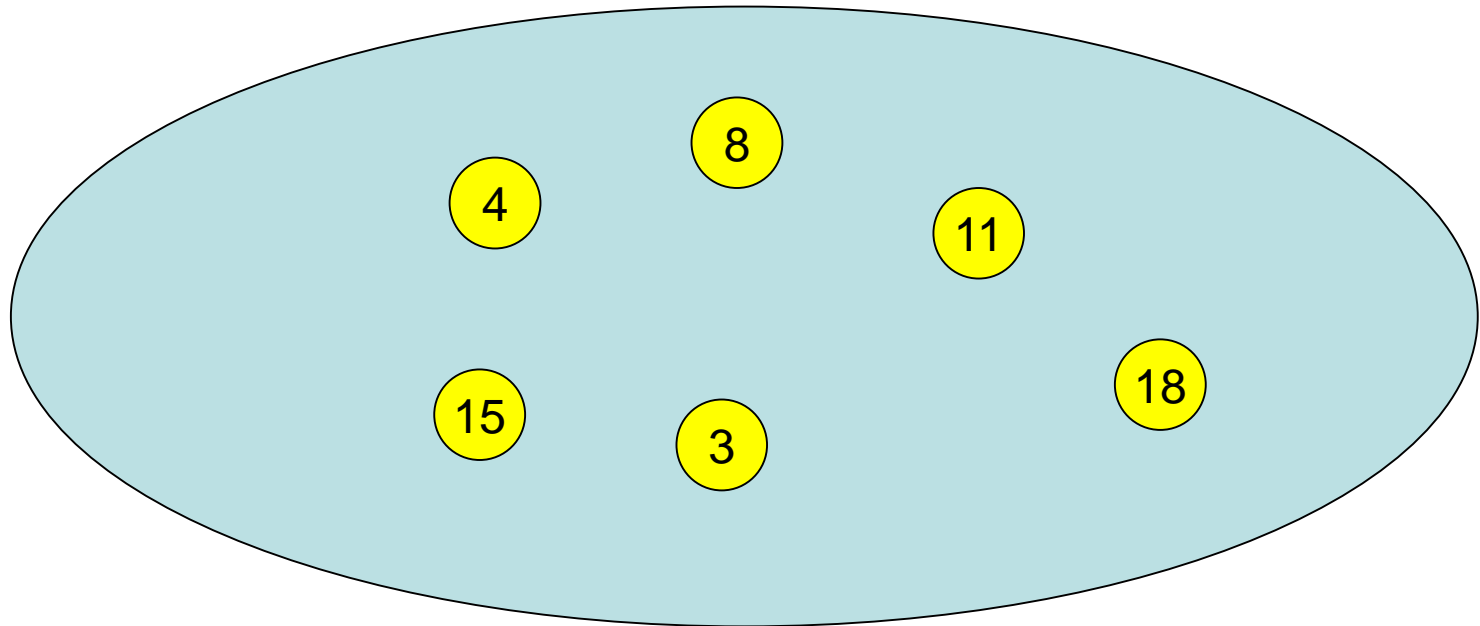

Dictionary Data Structure

S: set of elements in data structure

Every element **e** identified by **key(e)**.

Operations:

- **S.insert**(**e**: Element): $S := S \cup \{e\}$
- **S.delete**(**k**: Key): $S := S \setminus \{e\}$, where **e** is the element with **key(e)=k**
- **S.lookup**(**k**: Key): If there is an $e \in S$ with **key(e)=k**, output **e**, otherwise output \perp

Hashing

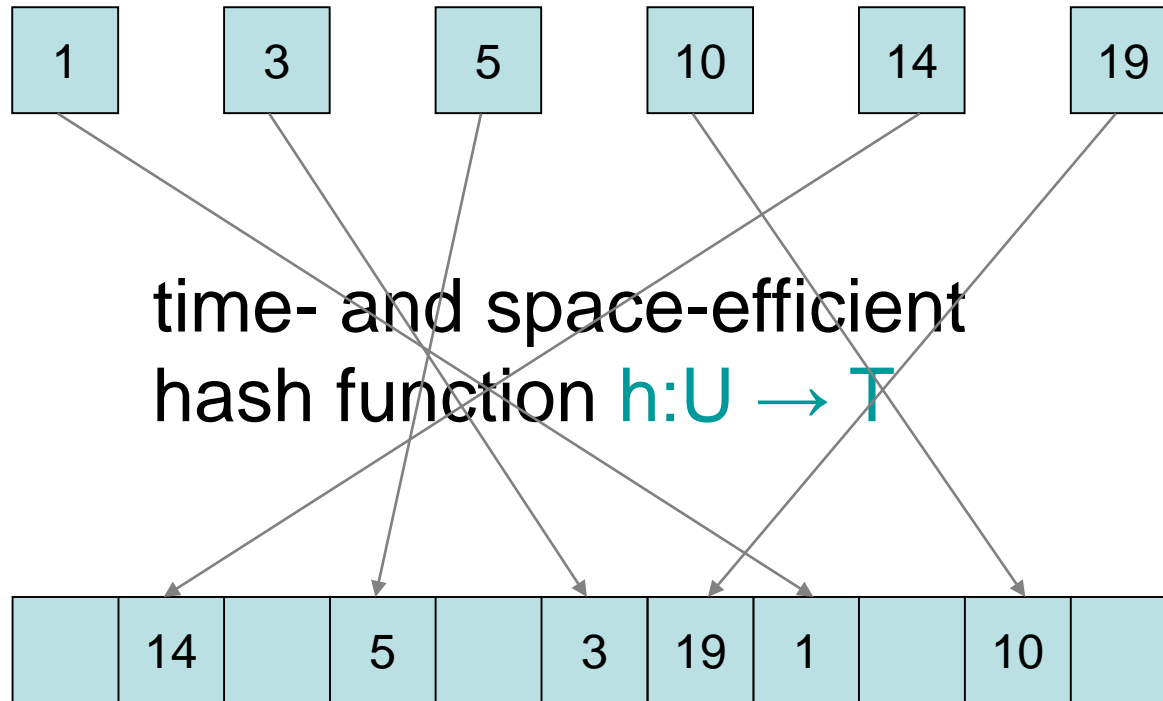

hash table T

Hashing

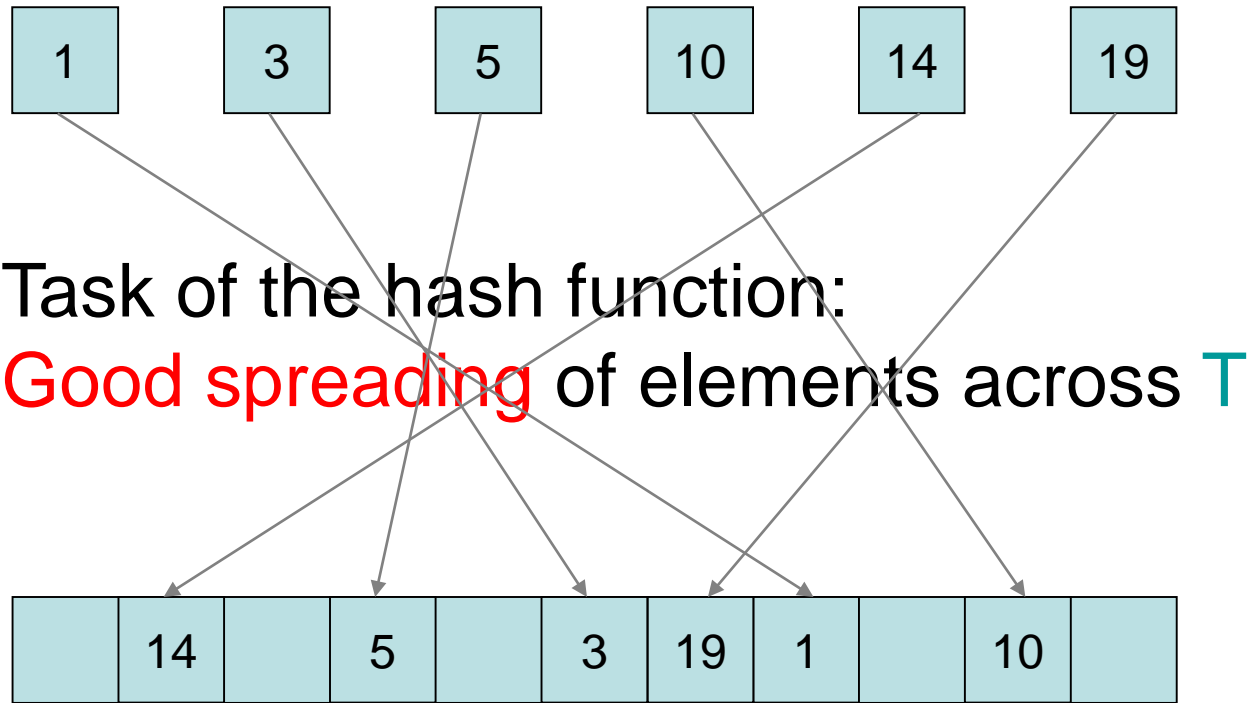

hash table **T**

Hashing

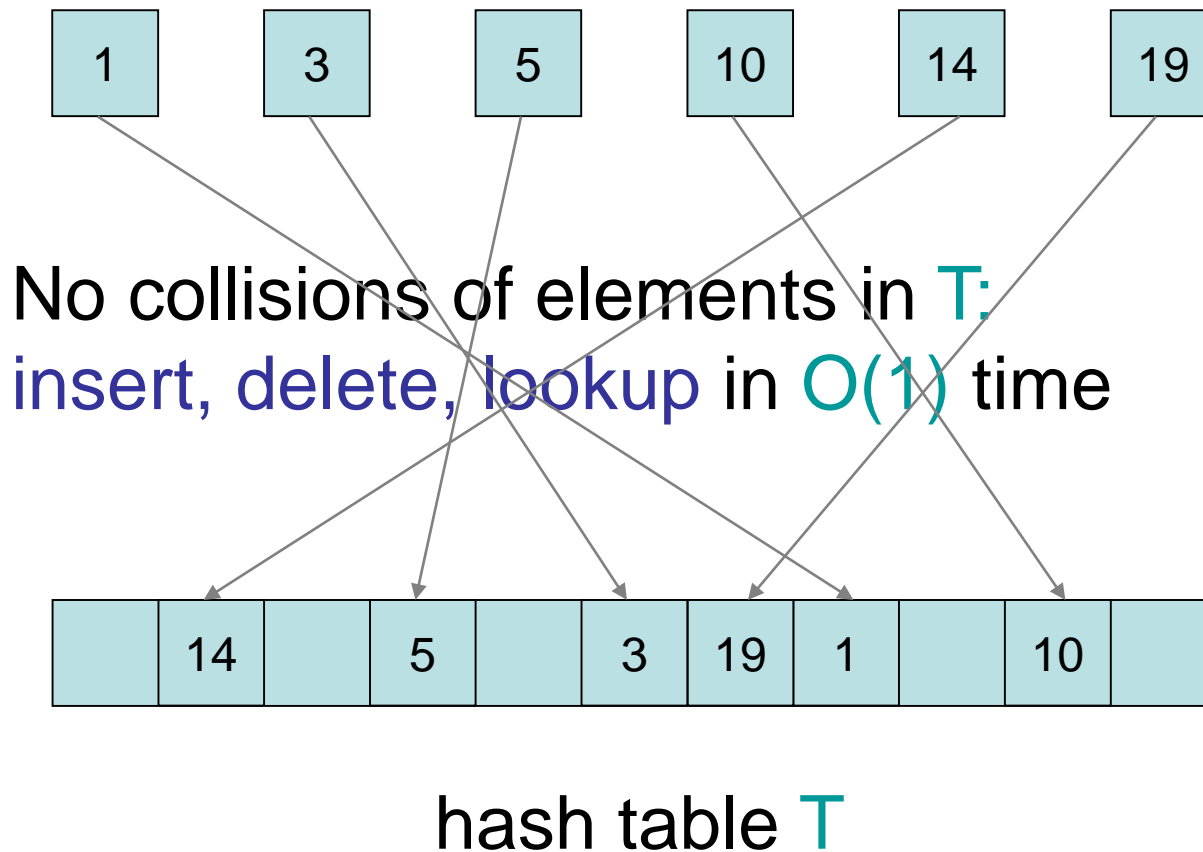

Hashing (no collisions)

Procedure `insert`(`e: Element`)
 `T[h(key(e))] := e`

Procedure `delete`(`k: Key`)
 if `key(T[h(k)])=k` then `T[h(k)] := ⊥`

Function `lookup`(`k: Key`): `Element ∪ {⊥}`
 return `T[h(k)]`

Hashing

Problem: handling collisions

Solutions:

- Closed addressing:
append elements in hash table entry to a list
- Open addressing:
linear, quadratic probing
- Two hash tables:
Cuckoo hashing

Open Addressing

Linear probing:

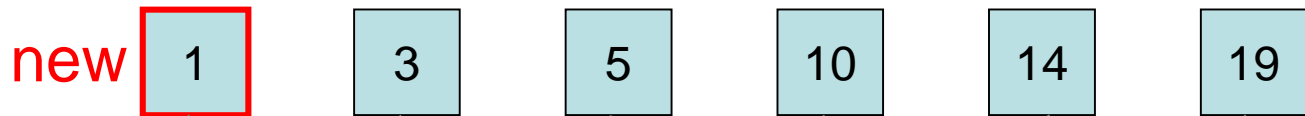

Store new element x in the first free slot starting with $T[i]$, where $i=h(x.key)$



Cuckoo Hashing

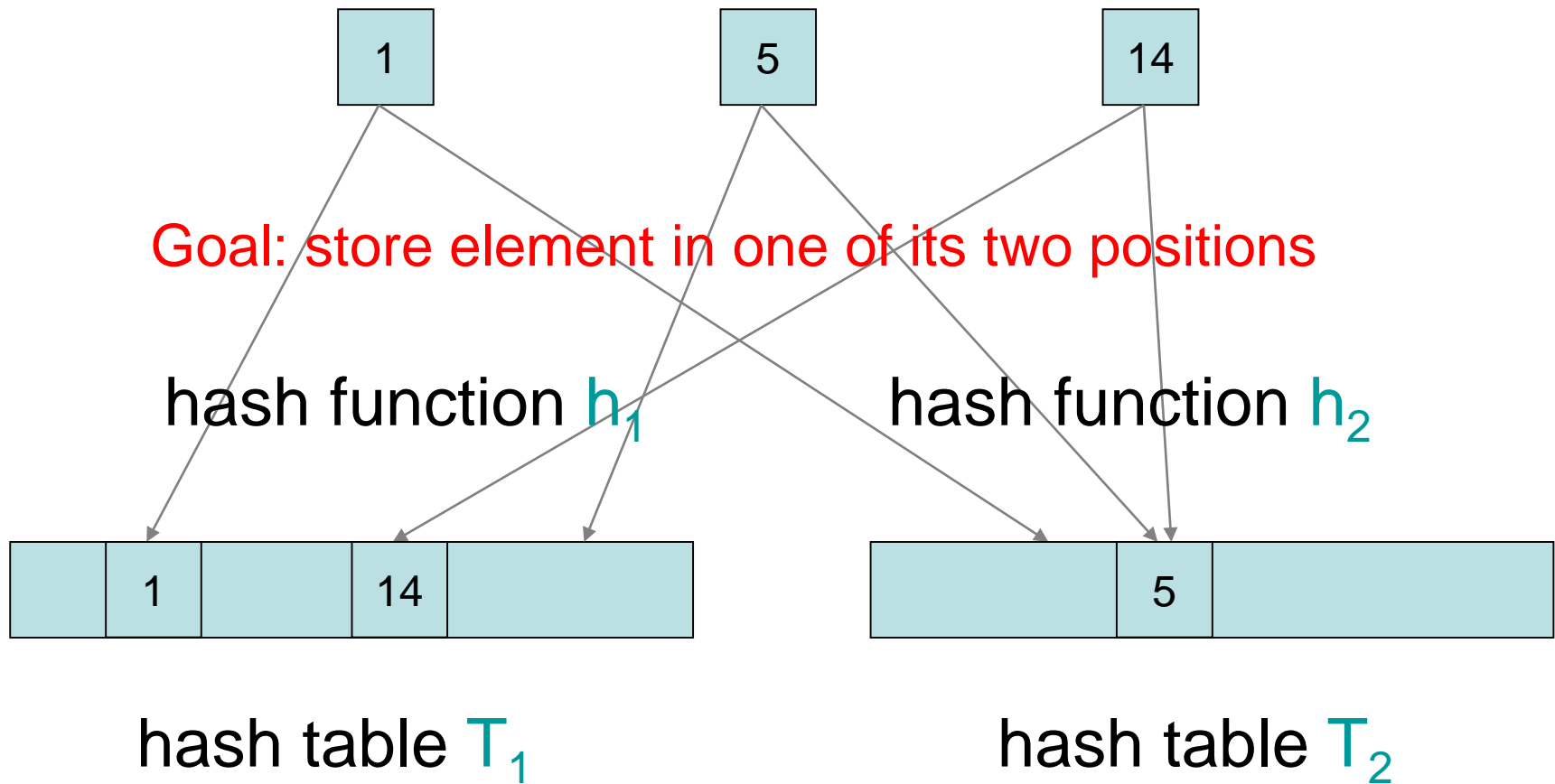

Cuckoo Hashing

T_1, T_2 : Array $[0..m-1]$ of Element

```
Procedure lookup(k: Key): Element  $\cup$  { $\perp$ }  
  if key( $T_1[h_1(k)]$ )=k then return  $T_1[h_1(k)]$   
  if key( $T_2[h_2(k)]$ )=k then return  $T_2[h_2(k)]$   
  return  $\perp$ 
```

```
Procedure delete(k: Key)  
  if key( $T_1[h_1(k)]$ )=k then  $T_1[h_1(k)] := \perp$   
  if key( $T_2[h_2(k)]$ )=k then  $T_2[h_2(k)] := \perp$ 
```

Cuckoo Hashing

```
Procedure insert(e: Element)
  // key(e) already in hash table?
  if key(T1[h1(key(e))])=key(e) then
    T1[h1(key(e))] := e; return
  if key(T2[h2(key(e))])=key(e) then
    T2[h2(key(e))] := e; return
  // no, then insert it
  while true do
    e ↔ T1[h1(key(e))] // switch e with element in T1
    if e = ⊥ then return
    e ↔ T2[h2(key(e))] // switch e with element in T2
    if e = ⊥ then return
```

Better: at most $d \log n$ often, where the constant d is „sufficiently large“. If more than $d \log n$ rounds are needed, then rehash all elements with new h_1, h_2

Cuckoo Hashing

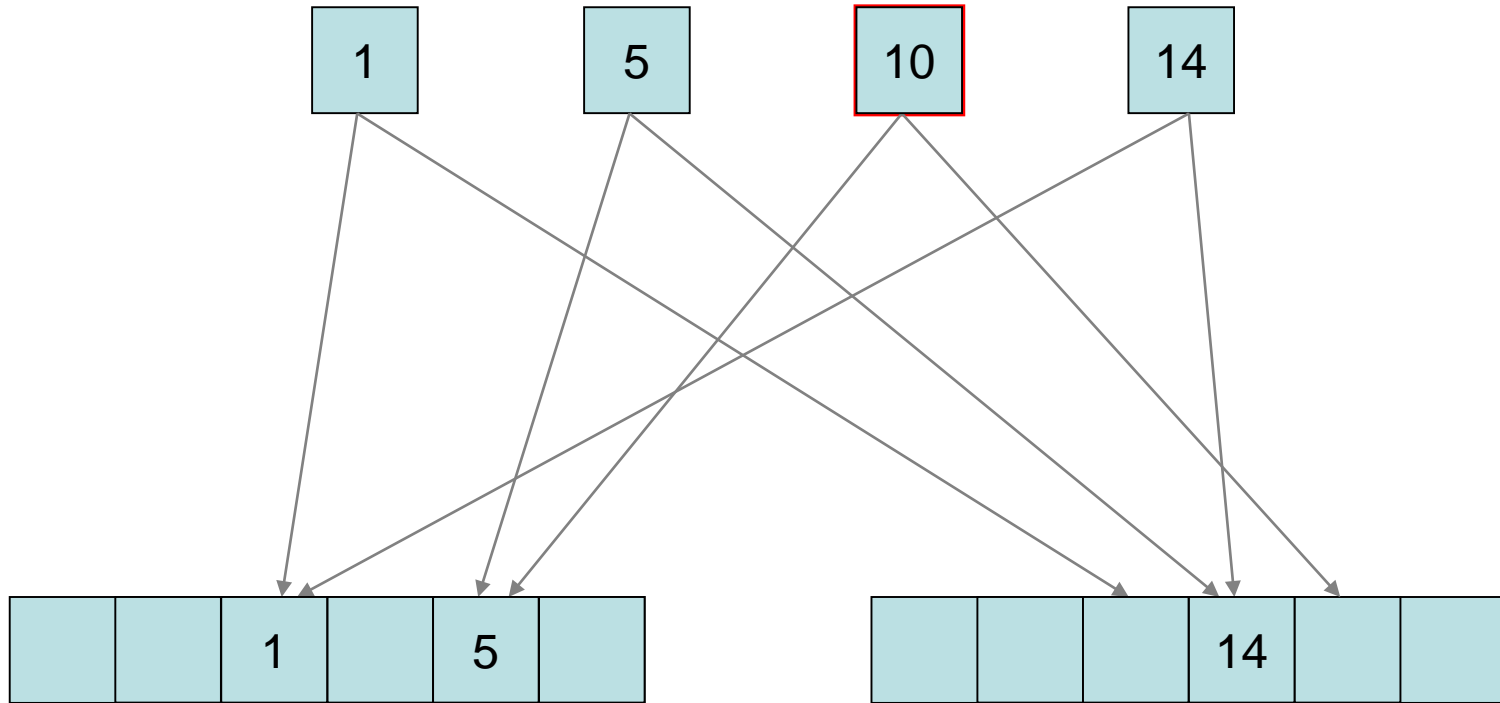

Cuckoo Hashing

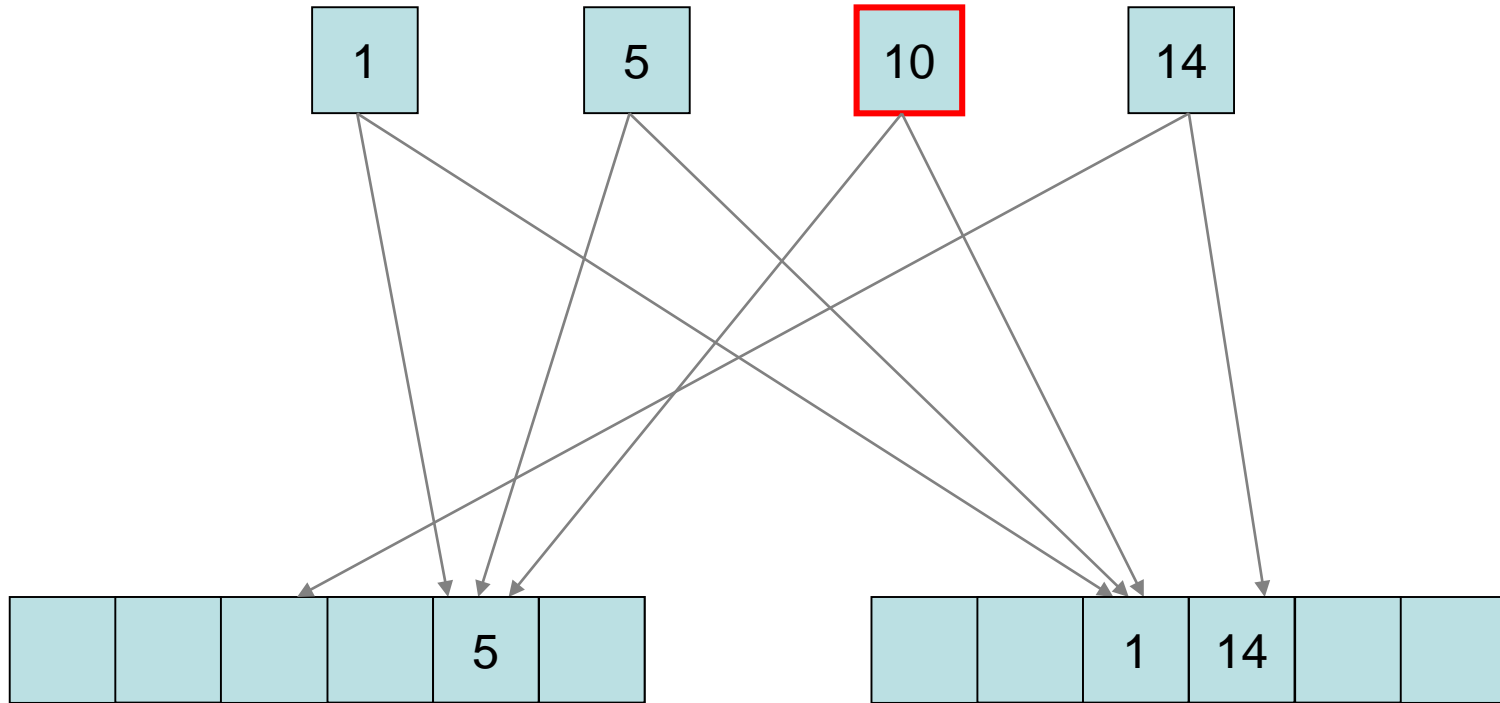

Infinite loop!

Cuckoo Hashing

Runtime:

- lookup, delete: $O(1)$ (worst case!)
- insert: $O(\text{number of replacements} + \text{possibly the time for a complete rehash})$

Runtime of insert operation: 2 cases

1. after t rounds, insert enters an infinite loop, which requires rehash
2. insert terminates after t rounds

Nevertheless, expected runtime of insert: $O(1)$ if $m \geq 2n$, where m is the hash table size.

Next Lecture

Topic: Dynamic programming and Greedy algorithms